

# ATELIER MTD-804SB

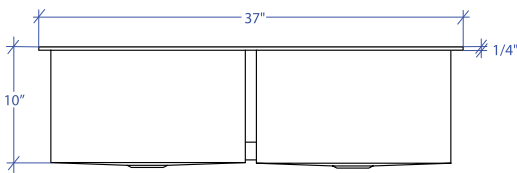

\*Custom ADA compliant sinks are available

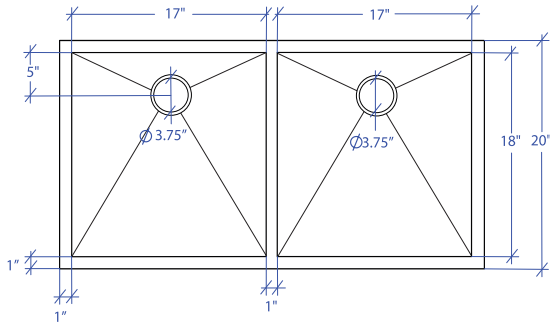

## • FEATURES

16-gauge type 304 stainless steel  
TRI-MOUNT™ installation system

## • TECHNICAL INFORMATION

External dimension: 37" L x 20" W x 10" D  
Basin dimensions:  
Left: 17" L x 18" W x 10" D  
Right: 17" L x 18" W x 10" D  
Frame width: 1"  
Frame thickness: 1/4"

## • FINISHES

Satin Brushed stainless steel

## • INSTALLATION OPTIONS

Flush-mount  
Drop-In  
Under-mount

## • MINIMUM CABINET SIZE (I.D.)

Flush-mount 40"  
Drop-In 37"  
Under-mount 41"

## • INDUSTRY'S ONLY STAINLESS STEEL SINK DESIGNED SPECIFICALLY TO BE FLUSH-MOUNTED

## • U.S. PATENT NO. 9,988,799

## • CANADIAN PATENT NO. 2579506

## • TRI-MOUNT INSTALLATION

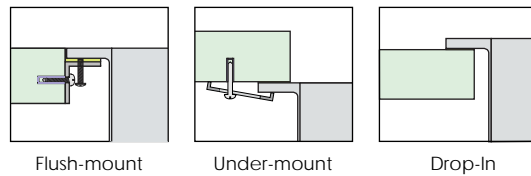

## • ACCESSORIES

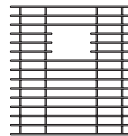

MBG-083SB  
Basin Grid

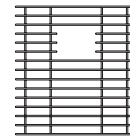

MBG-083SB  
Basin Grid



MCB-801BB  
Cutting Board

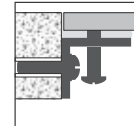

MTK-113AL  
Mounting Kit

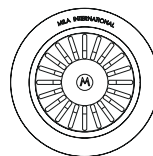

MKD-101SB  
Strainer

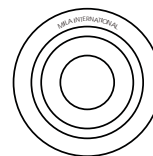

MDC-101SB  
Disposal Collar

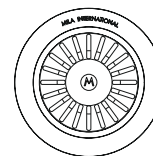

MDC-102SB  
Disposal Collar

PROJECT INFORMATION			
Project			
Date	/ /	QTY	
Specifier			
Contact			
Note			