

# ORION MOUD-803SB

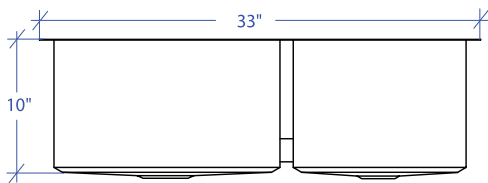

\*Custom ADA compliant sinks are available

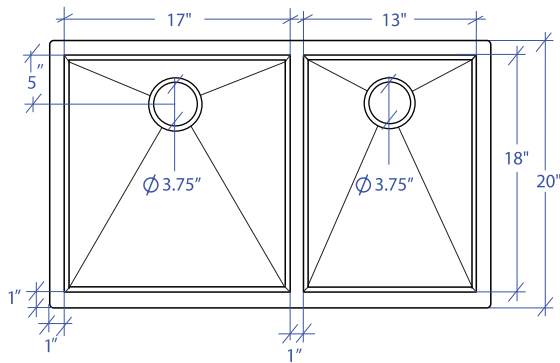

- FEATURES**  
 16-gauge type 304 stainless steel  
 Bevel basin design
- TECHNICAL INFORMATION**  
 External dimension: 33"Lx20"Wx10"D  
 Basin dimensions:  
 Left: 17"Lx18"Wx10"D  
 Right: 13"Lx18"Wx10"D
- FINISHES**  
 Satin Brushed stainless steel
- INSTALLATION OPTIONS**  
 Under-mount
- MINIMUM CABINET SIZE (I.D.)**  
 Under-mount 36"
- US DESIGN PATENT D618,324 S**

- DUAL-MOUNT INSTALLATION**

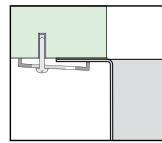

Under-mount

- ACCESSORY OPTIONS**

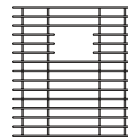

MBG-083SB  
Basin Grid

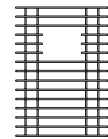

MBG-082SB  
Basin Grid

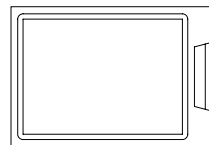

MCB-801BB  
Cutting Board

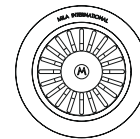

MKD-101SB  
Strainer

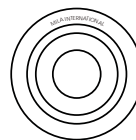

MDC-101SB  
Disposal Collar

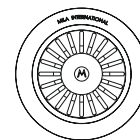

MDC-102SB  
Disposal Collar

PROJECT INFORMATION			
Project			
Date	/ /	QTY	
Specifier			
Contact			
Note			