

# ORION MOUS-503SB

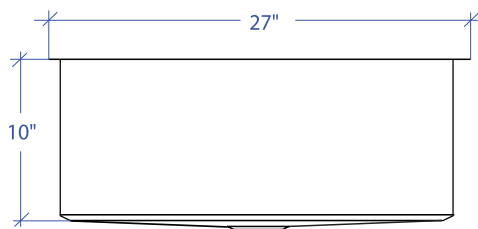

\*Custom ADA compliant sinks are available

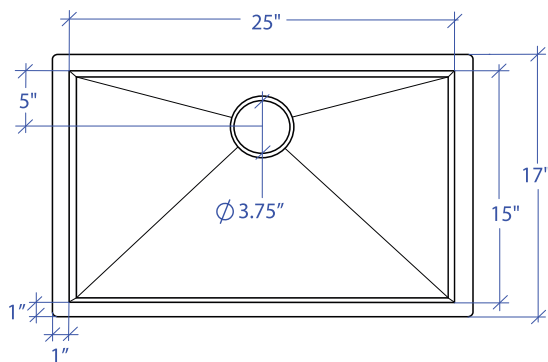

## • FEATURES

16-gauge type 304 stainless steel  
Bevel basin design

## • TECHNICAL INFORMATION

External dimension: 27" L x 17" W x 10" D  
Basin dimensions: 25" L x 15" W x 10" D

## • FINISHES

Satin Brushed stainless steel

## • INSTALLATION OPTIONS

Under-mount

## • MINIMUM CABINET SIZE (I.D.)

Under-mount 30"

## • US DESIGN PATENT D618,324 S

## • DUAL-MOUNT INSTALLATION

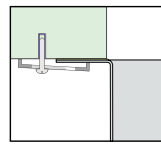

Under-mount

## • ACCESSORY OPTIONS

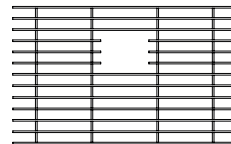

MBG-055SB  
Basin Grid

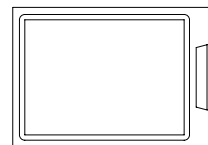

MCB-501BB  
Cutting Board

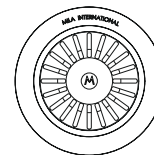

MKD-101SB  
Strainer

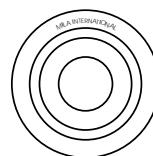

MKD-101SB  
Disposal Collar

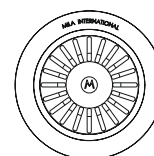

MDC-102SB  
Disposal Collar

PROJECT INFORMATION			
Project			
Date	/ /	QTY	
Specifier			
Contact			
Note			