

ORION MOUS-803SB

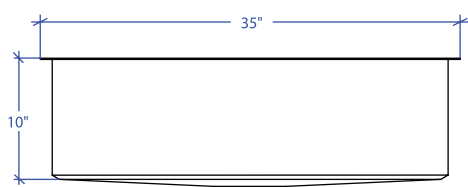

*Custom ADA compliant sinks are available

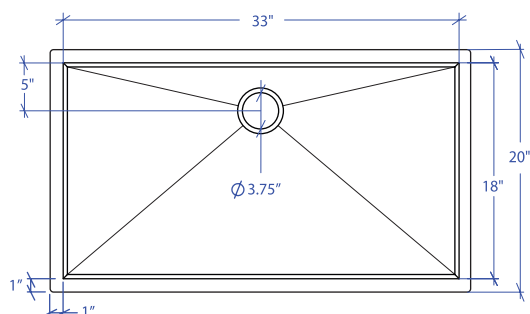

- **FEATURES**
16-gauge type 304 stainless steel
Bevel basin design
- **TECHNICAL INFORMATION**
External dimension: 35" Lx20" Wx10" D
Basin dimensions: 33" Lx18" Wx10" D
- **FINISHES**
Satin Brushed stainless steel
- **INSTALLATION OPTIONS**
Under-mount
- **MINIMUM CABINET SIZE (I.D.)**
Under-mount 38"

- **US DESIGN PATENT D618,324 S**

- **DUAL-MOUNT INSTALLATION**

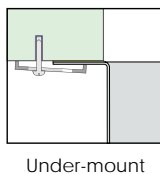

- **ACCESSORY OPTIONS**

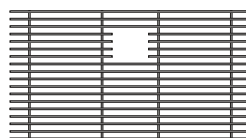

MBG-087SB
Basin Grid

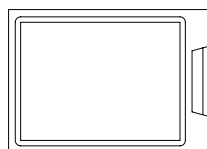

MCB-801BB
Cutting Board

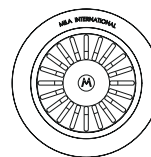

MKD-101SB
Strainer

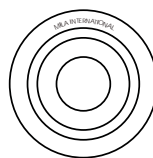

MDC-101SB
Disposal Collar

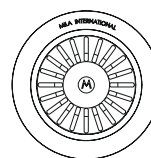

MDC-102SB
Disposal Collar

PROJECT INFORMATION			
Project			
Date	/ /	QTY	
Specifier			
Contact			
Note			