

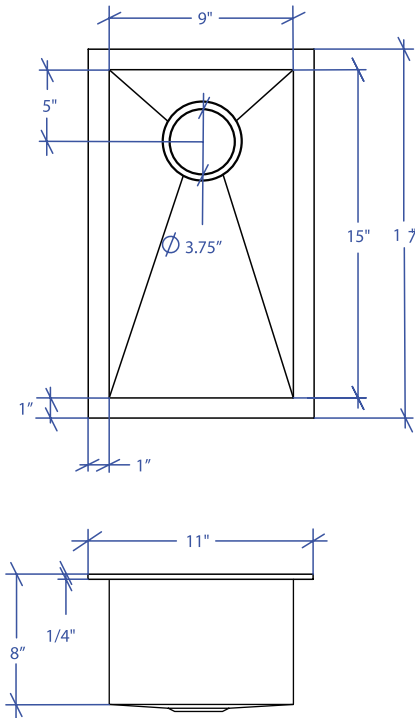

*Custom ADA compliant sinks are available



• FEATURES

16-gauge type 304 stainless steel
TRI-MOUNT™ installation system

• TECHNICAL INFORMATION

External dimension: 11" Lx17" Wx8" D
Basin dimensions: 9" Lx15" Wx8" D
Rim width: 1"
Rim thickness: 1/4"

• FINISHES

Satin brushed stainless steel

• INSTALLATION OPTIONS

Flush-mount
Drop-In
Under-mount

• MINIMUM CABINET SIZE (I.D.)

Flush-mount 14"
Drop-In 11"
Under-mount 15"

• INDUSTRY'S ONLY STAINLESS STEEL SINK DESIGNED SPECIFICALLY TO BE FLUSH-MOUNTED

• U.S. PATENT NO. 9,988,799

• CANADIAN PATENT NO. 2579506

• TRI-MOUNT INSTALLATION

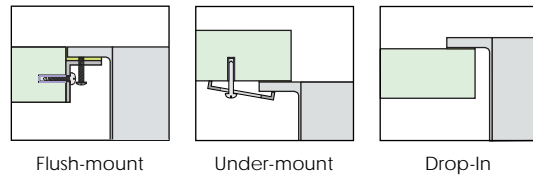

• ACCESSORIES

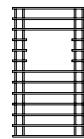

MBG-051SB
Basin Grid

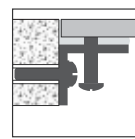

MTK-101AL
Mounting Kit

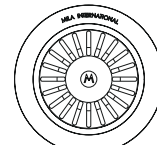

MKD-101SB
Strainer

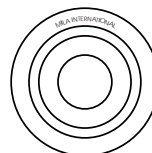

MDC-101SB
Disposal Collar

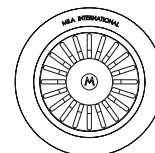

MDC-102SB
Disposal Collar

PROJECT INFORMATION			
Project			
Date	/ /	QTY	
Specifier			
Contact			
Note			