

# ORION MOUS-805SB

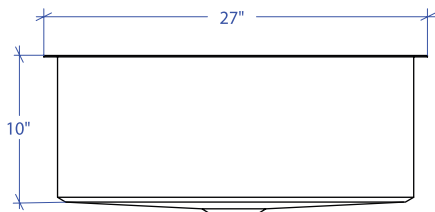

\*Custom ADA compliant sinks are available

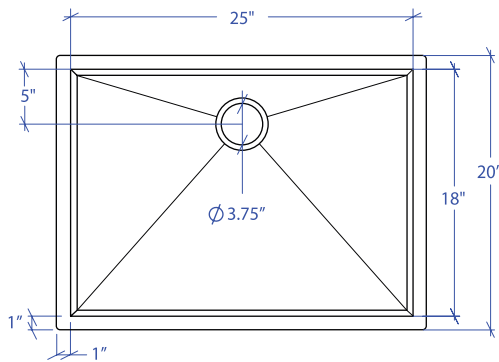

## • FEATURES

16-gauge type 304 stainless steel  
Bevel basin design

## • TECHNICAL INFORMATION

External dimension: 27" Lx20" Wx10" D  
Basin dimensions: 25" Lx18" Wx10" D  
Rim width: 1"  
Rim thickness: 1/16"

## • FINISHES

Satin brushed stainless steel

## • INSTALLATION OPTIONS

Under-mount

## • MINIMUM CABINET SIZE (I.D.)

Under-mount 30"

## • US DESIGN PATENT D618,324 S

## • DUAL-MOUNT INSTALLATION

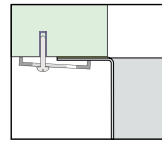

Under-mount

## • ACCESSORY OPTIONS



MBG-085SB  
Basin Grid

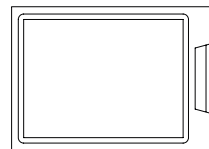

MCB-801BB  
Cutting Board

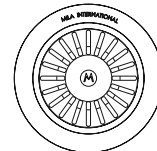

MKD-101SB  
Strainer

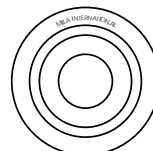

MDC-101SB  
Disposal Collar

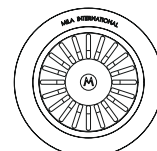

MDC-102SB  
Disposal Collar

PROJECT INFORMATION			
Project			
Date	/ /	QTY	
Specifier			
Contact			
Note			