

ORION MOUD-804SB

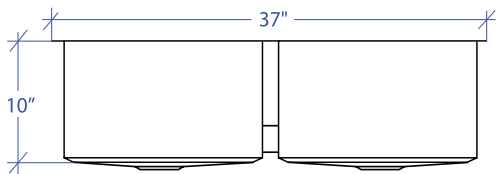

*Custom ADA compliant sinks are available

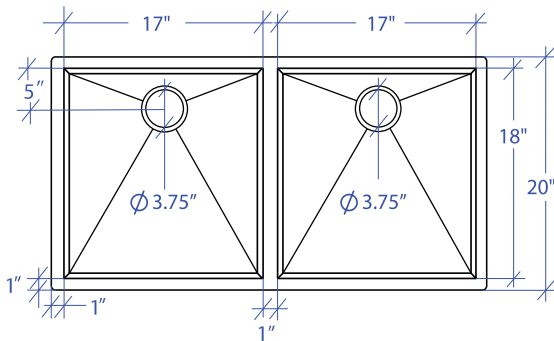

• FEATURES

16-gauge type 304 stainless steel
Bevel basin design

• TECHNICAL INFORMATION

External dimension: 37"Lx20"Wx10"D
Basin dimensions:
Left: 17"Lx18"Wx10"D
Right: 17"Lx18"Wx10"D
Rim width: 1"
Rim thickness: 1/16"

• FINISHES

Satin brushed stainless steel

• INSTALLATION OPTIONS

Under-mount

• MINIMUM CABINET SIZE (I.D.)

Under-mount 40"

• US DESIGN PATENT D618,324 S

• DUAL-MOUNT INSTALLATION

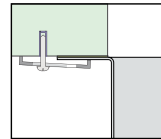

Under-mount

• ACCESSORY OPTIONS

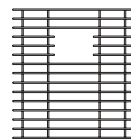

MBG-083SB
Basin Grid

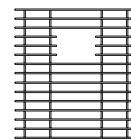

MBG-083SB
Basin Grid

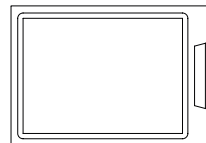

MCB-801BB
Cutting Board

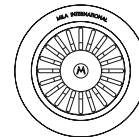

MKD-101SB
Strainer



MDC-101SB
Disposal Collar

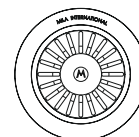

MDC-102SB
Disposal Collar

PROJECT INFORMATION			
Project			
Date	/ /	QTY	
Specifier			
Contact			
Note			

UNDER-MOUNT