

ORION MOEU-801SB

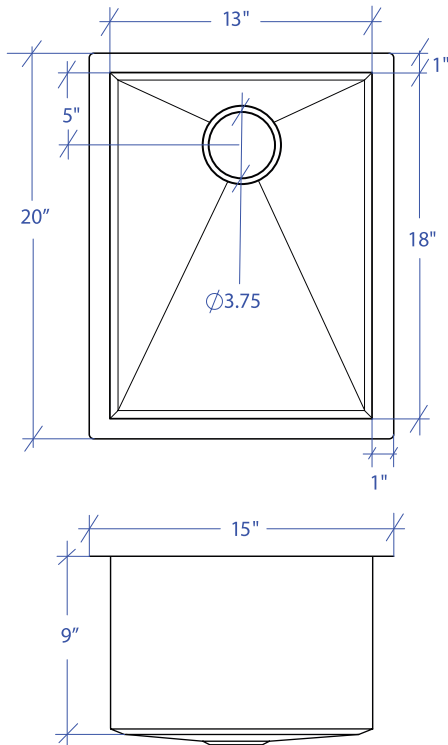

*Custom ADA compliant sinks are available



- **FEATURES**
16-gauge type 304 stainless steel
Bevel basin design
- **TECHNICAL INFORMATION**
External dimension: 15" Lx20" Wx9" D
Basin dimensions: 13" Lx18" Wx9" D
Rim width: 1"
Rim thickness: 1/16"
- **FINISHES**
Satin brushed stainless steel
- **INSTALLATION OPTIONS**
Drop-in
Under-mount
- **MINIMUM CABINET SIZE (I.D.)**
Under-mount 18"
- **US DESIGN PATENT D618,324 S**

• DUAL-MOUNT INSTALLATION

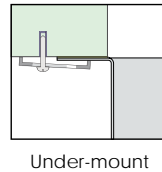

• ACCESSORY OPTIONS

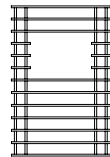

MBG-082SB
Basin Grid

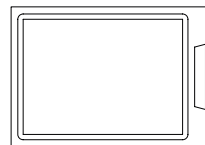

MCB-501BB
Cutting Board

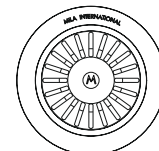

MKD-101SB
Strainer

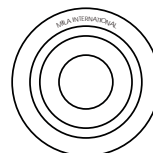

MDC-101SB
Disposal Collar

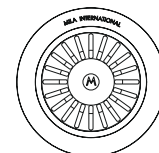

MDC-102SB
Disposal Collar

PROJECT INFORMATION			
Project			
Date	/ /	QTY	
Specifier			
Contact			
Note			

ENTERTAINMENT UNDER-MOUNT