

LOUVRE MLFS-654SB

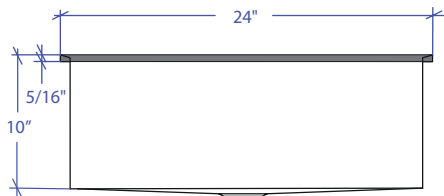

*Flush-Mount Installation Kit is included with each sink
*Custom ADA compliant versions are available

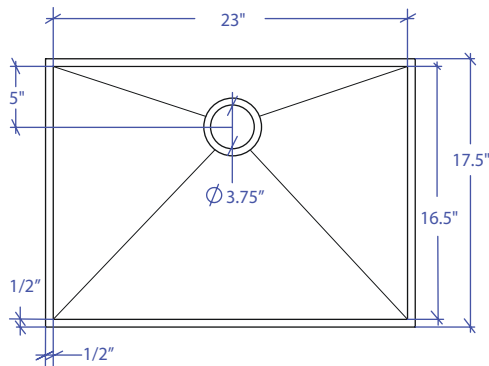

• FEATURES

- 16-gauge type 304 stainless steel
- Stainless steel rim support tubing
- Bevel rim and basin design

• TECHNICAL INFORMATION

- External dimension: 24" L x 17.5" W x 10" D
- Basin dimensions: 23" L x 16.5" W x 10" D
- Rim width: 1/2"
- Rim thickness: 5/16"

• FINISHES

- Satin brushed stainless steel

• INSTALLATION OPTIONS

- Flush-mount

• MINIMUM CABINET SIZE (I.D.)

- Flush-mount 27"

• INDUSTRY'S ONLY STAINLESS STEEL SINK DESIGNED SPECIFICALLY TO BE FLUSH-MOUNTED

• INTERNATIONAL PATENT PENDING

• FLUSH-MOUNT INSTALLATION

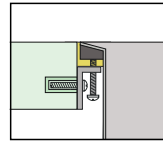

Flush-mount

• ACCESSORIES OPTIONS

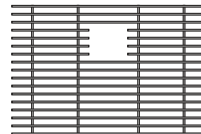

MBG-6509SB
Basin Grid

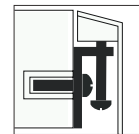

Flush Mount Kit
(Included)
MTK-617AL

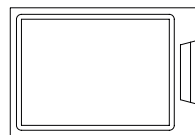

MCB-651BB
Cutting Board

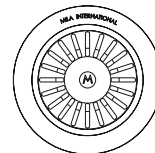

MKD-101SB
Strainer

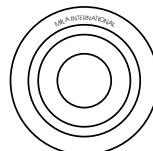

MDC-101SB
Disposal Collar

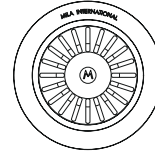

MDC-102SB
Disposal Collar

PROJECT INFORMATION

Project			
Date	/ /	QTY	
Specifier			
Contact			
Note			

FLUSH-MOUNT