

LOUVRE MLFS-655GPSB

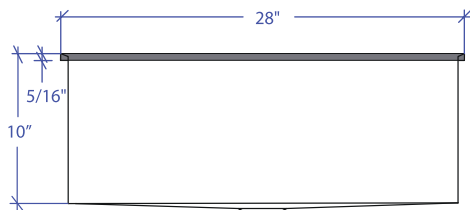

*Flush-Mount Installation Kit is included with each sink
*Custom ADA compliant versions are available

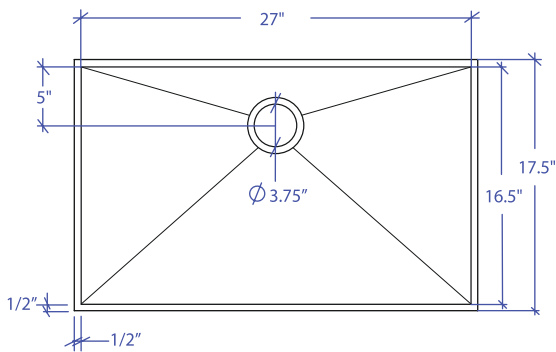

• FEATURES

- 16-gauge type 304 stainless steel
- Stainless steel rim support tubing
- Bevel rim and basin design

• TECHNICAL INFORMATION

- External dimension: 28" Lx17.5" Wx10" D
- Basin dimensions: 27" Lx16.5" Wx10" D
- Rim width: 1/2"
- Rim thickness: 5/16"

• FINISHES

- Graphite PVD satin brushed stainless steel

• INSTALLATION OPTIONS

- Flush-mount

• MINIMUM CABINET SIZE (I.D.)

- Flush-mount 31"

• INDUSTRY'S ONLY STAINLESS STEEL SINK DESIGNED SPECIFICALLY TO BE FLUSH-MOUNTED

• INTERNATIONAL PATENT PENDING

• FLUSH-MOUNT INSTALLATION

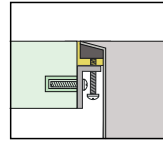

Flush-mount

• ACCESSORIES OPTIONS

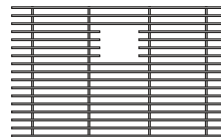

MBG-6517GPSB
Basin Grid

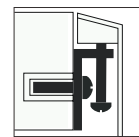

Flush Mount Kit
(Included)
MTK-618AL

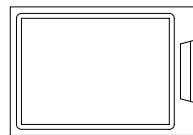

MCB-651BB
Cutting Board

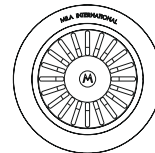

MKD-101GPSB
Strainer

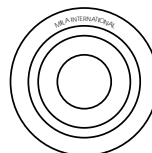

MDC-101GPSB
Disposal Collar

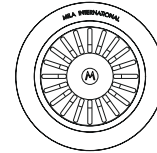

MDC-102GPSB
Disposal Collar

PROJECT INFORMATION

Project			
Date	/ /	QTY	
Specifier			
Contact			
Note			

FLUSH-MOUNT