

ARC MARFS-653GDSB

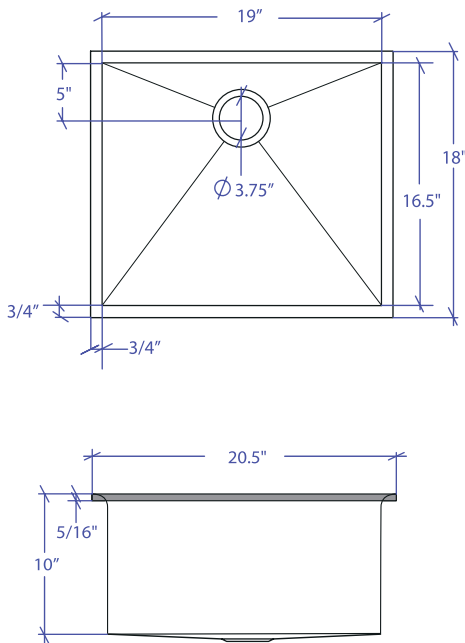

*Flush-Mount Installation Kit is included with each sink
*Custom ADA compliant versions are available



FEATURES

- 16-gauge type 304 stainless steel
- Solid brass under rim support
- 1/4" round profile basin

TECHNICAL INFORMATION

- External dimension: 20.5" L x 18" W x 10" D
- Basin dimensions: 19" L x 16.5" W x 10" D
- Frame width: 3/4" • Frame thickness: 5/16"

FINISHES

- Gold PVD Satin Brushed stainless steel

INSTALLATION OPTIONS

- Flush-mount • Drop-in

MINIMUM CABINET SIZE (I.D.)

- Flush-mount 19.5"

INDUSTRY'S ONLY STAINLESS STEEL SINK DESIGNED SPECIFICALLY TO BE FLUSH-MOUNTED

INTERNATIONAL PATENT PENDING

INSTALLATION TYPE

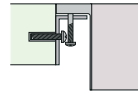

Flush-mount



Included MTK-610AL
Flush Mount Kit

OPTIONAL ACCESSORIES

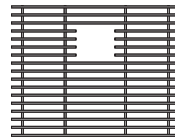

MBG-6506GDSB
Basin Grid

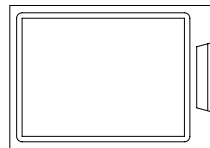

MCB-651BB
Cutting Board

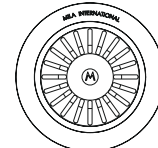

MKD-101GDSB
Strainer

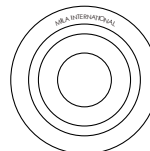

MDC-101GDSB
Disposal Collar

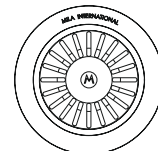

MDC-102GDSB
Disposal Collar

PROJECT INFORMATION			
Project			
Date	/ /	QTY	
Specifier			
Contact			
Note			