

# WORKSTATION MFWS-637GDSB

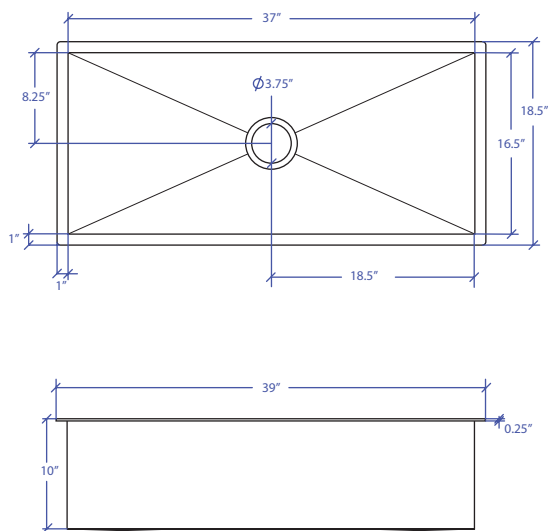

**INDUSTRY'S ONLY STAINLESS STEEL SINK DESIGNED SPECIFICALLY TO BE FLUSH-MOUNTED**



## FEATURES

- 16-gauge type 304 stainless steel
- 5-gauge 304 stainless steel rim

## TECHNICAL INFORMATION

- External dimension: 39" L x 18.5" W x 10" D
- Basin dimensions: 37" L x 16.5" W x 10" D
- Rim width: 1" • Rim thickness: 1/4"

## FINISHES

- Gold PVD Satin Brushed stainless steel

## INSTALLATION OPTIONS

- Flush-mount • Top-mount

## MINIMUM CABINET SIZE (I.D.)

- Flush-mount 40"

## INSTALLATION TYPE

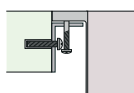

Flush-mount

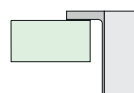

Drop-in



Included MTK-620SS  
Flush Mount Kit

## OPTIONAL ACCESSORIES

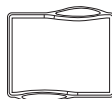

MWCB-651GDSB  
Cutting Board

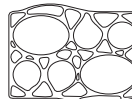

MWBM-651GDSB  
Bain Marie

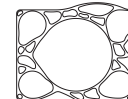

MWSM-651GDSB  
Salad Mixer



MWC-651GDSB  
Colander

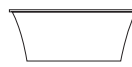

MWSS-651GDSB  
Side Sink



MWRG-651GDSB  
Roll up Grid



MWCBFLW-651GDSB  
Cutting Board

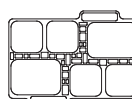

MWBMFLW-651GDSB  
Bain Marie

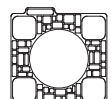

MWSMFLW-651GDSB  
Salad Mixer



MWCFLW-651GDSB  
Colander



MWSSFLW-651GDSB  
Side Sink



MWSA-651GDSB  
Salad Spinner Adapter



MBG-637GDSB Basin Grid



MKD-101GDSB  
Strainer



MDC-101GDSB  
Disposal Collar



MDC-102GDSB  
Disposal Collar

US Patent No. 9,988,799 CA Patent No. 2579506  
International Patent Pending

PROJECT INFORMATION			
Project			
Date	/ /	QTY	
Specifier			
Contact			
Note			