

WORKSTATION MFWS-637SB

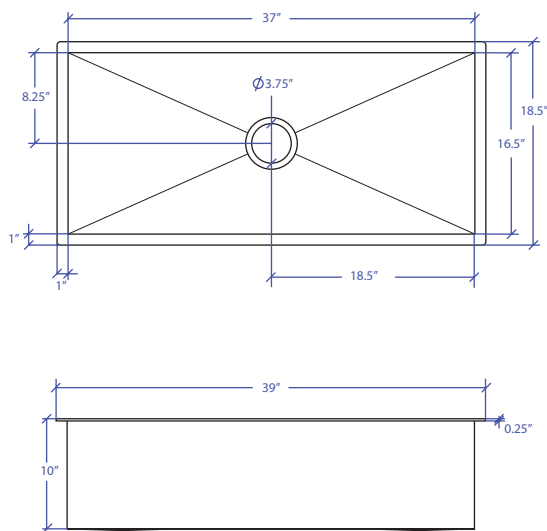

INDUSTRY'S ONLY STAINLESS STEEL SINK DESIGNED SPECIFICALLY TO BE FLUSH-MOUNTED



US Patent No. 9,988,799 CA Patent No. 2579506
International Patent Pending

PROJECT INFORMATION			
Project			
Date	/ /	QTY	
Specifier			
Contact			
Note			

FEATURES

- 16-gauge type 304 stainless steel
- 5-gauge 304 stainless steel rim

TECHNICAL INFORMATION

- External dimension: 39" L x 18.5" W x 10" D
- Basin dimensions: 37" L x 16.5" W x 10" D
- Rim width: 1" • Rim thickness: 1/4"

FINISHES

- Satin Brushed stainless steel

INSTALLATION OPTIONS

- Flush-mount • Top-mount

MINIMUM CABINET SIZE (I.D.)

- Flush-mount 40"

INSTALLATION TYPE

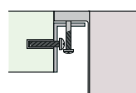

Flush-mount

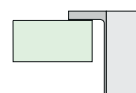

Drop-in



Included MTK-620SS
Flush Mount Kit

OPTIONAL ACCESSORIES

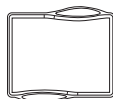

MWCB-651SB
Cutting Board

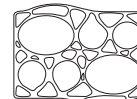

MWBM-651SB
Bain Marie

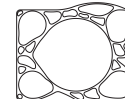

MWSM-651SB
Salad Mixer



MWC-651SB
Colander



MWSS-651SB
Side Sink



MWRG-651SB
Roll up Grid

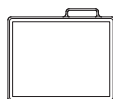

MWCBFLW-651SB
Cutting Board

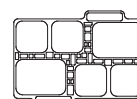

MWBMFLW-651SB
Bain Marie

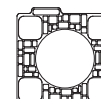

MWSMFLW-651SB
Salad Mixer



MWCFW-651SB
Colander



MWSSFLW-651SB
Side Sink



MWSA-651SB
Salad Spinner Adapter



MBG-637SB Basin Grid



MKD-101SB
Strainer



MDC-101SB
Disposal Collar



MDC-102SB
Disposal Collar

FLUSH-MOUNT