

ATELIER MTS-503SB

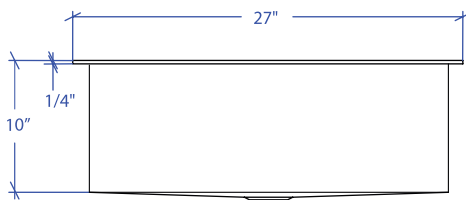

*Custom ADA compliant sinks are available

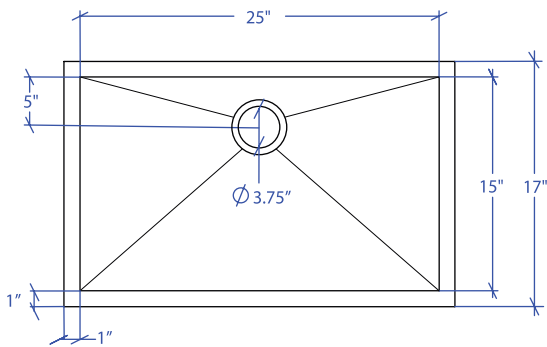

• FEATURES

16-gauge type 304 stainless steel
TRI-MOUNT™ installation system

• TECHNICAL INFORMATION

External dimension: 27" Lx17" Wx10" D
Basin dimensions: 25" Lx15" Wx10" D
Rim width: 1"
Rim thickness: 1/4"

• FINISHES

Satin brushed stainless steel

• INSTALLATION OPTIONS

Flush-mount
Drop-in
Under-mount

• MINIMUM CABINET SIZE (I.D.)

Flush-mount 30"
Drop-In 27"
Under-mount 31"

• INDUSTRY'S ONLY STAINLESS STEEL SINK DESIGNED SPECIFICALLY TO BE FLUSH-MOUNTED

• U.S. PATENT NO. 9,988,799

• CANADIAN PATENT NO. 2579506

• TRI-MOUNT INSTALLATION

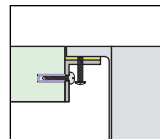

Flush-mount

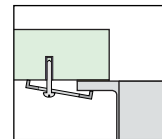

Under-mount

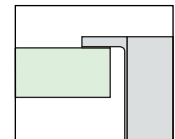

Drop-in

• ACCESSORIES

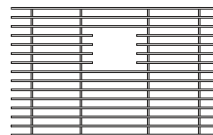

MBG-055SB
Basin Grid

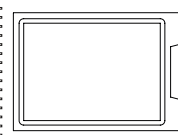

MCB-501BB
Cutting Board

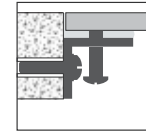

MTK-104AL
Mounting Kit

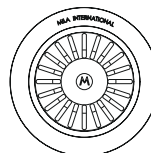

MKD-101SB
Strainer

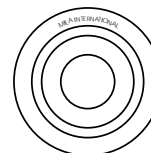

MDC-101SB
Disposal Collar

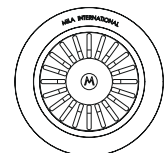

MDC-102SB
Disposal Collar

| PROJECT INFORMATION | | | |
|---------------------|-----|-----|--|
| Project | | | |
| Date | / / | QTY | |
| Specifier | | | |
| Contact | | | |
| Note | | | |