

ATELIER MTS-651SB

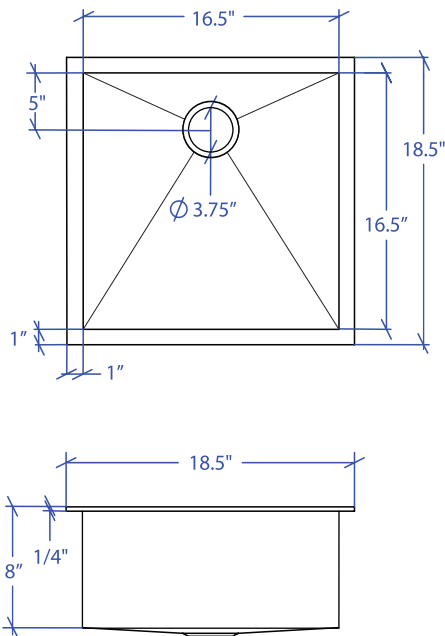

*Custom ADA compliant sinks are available



• FEATURES

16-gauge type 304 stainless steel
TRI-MOUNT™ installation system

• TECHNICAL INFORMATION

External dimension: 18.5" L x 18.5" W x 8" D
Basin dimensions: 16.5" L x 16.5" W x 8" D
Rim width: 1"
Rim thickness: 1/4"

• FINISHES

Satin brushed stainless steel

• INSTALLATION OPTIONS

Flush-mount
Drop-in
Under-mount

• MINIMUM CABINET SIZE (I.D.)

Flush-mount 21.5"
Drop-in 18.5"
Under-mount 22.5"

• INDUSTRY'S ONLY STAINLESS STEEL SINK DESIGNED SPECIFICALLY TO BE FLUSH-MOUNTED

• U.S. PATENT NO. 9,988,799

• CANADIAN PATENT NO. 2579506

• TRI-MOUNT INSTALLATION

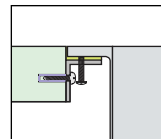

Flush-mount

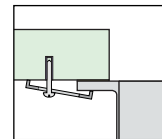

Under-mount

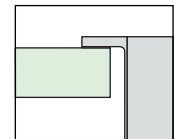

Drop-in

• ACCESSORIES

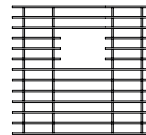

MBG-6516SB
Basin Grid

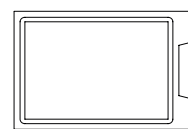

MCB-651BB
Cutting Board

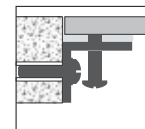

MTK-601AL
Mounting Kit

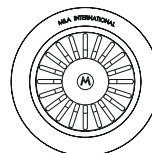

MKD-101SB
Strainer

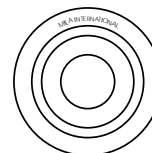

MDC-101SB
Disposal Collar

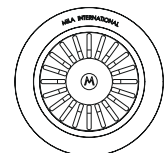

MDC-102SB
Disposal Collar

PROJECT INFORMATION			
Project			
Date	/ /	QTY	
Specifier			
Contact			
Note			