

FLATIRON MUS-806SB

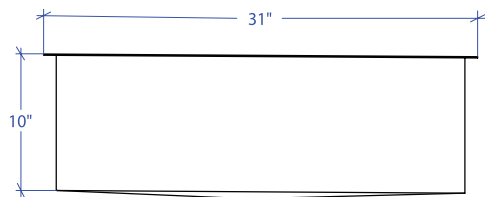

*Custom ADA compliant versions are available

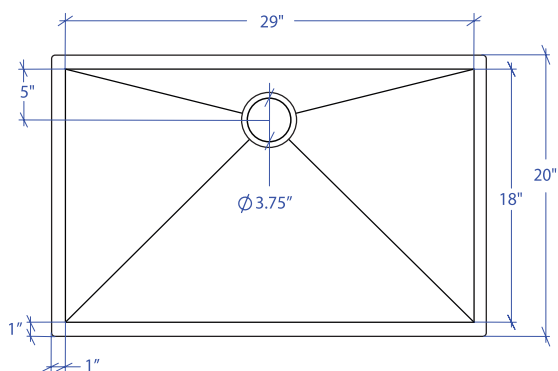

- **FEATURES**
16-gauge type 304 stainless steel
90° zero radius design
- **TECHNICAL INFORMATION**
External dimension: 31" Lx20" Wx10" D
Basin dimensions: 29" Lx18" Wx10" D
- **FINISHES**
Satin Brushed stainless steel
- **INSTALLATION OPTIONS**
Under-mount
- **MINIMUM CABINET SIZE (I.D.)**
Under-mount 34"

• DUAL-MOUNT INSTALLATION

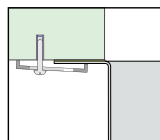

Under-mount

• ACCESSORY OPTIONS

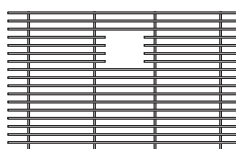

MBG-089SB
Basin Grid

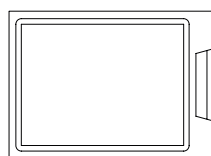

MCB-801BB
Cutting Board

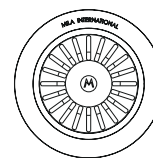

MKD-101SB
Strainer

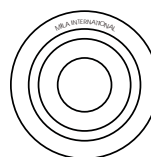

MDC-101SB
Disposal Collar

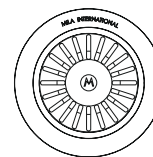

MDC-102SB
Disposal Collar

PROJECT INFORMATION			
Project			
Date	/ /	QTY	
Specifier			
Contact			
Note			

UNDER-MOUNT