

# FLATIRON MUD-503SB

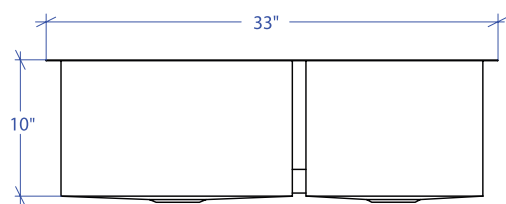

\*Custom ADA compliant versions are available

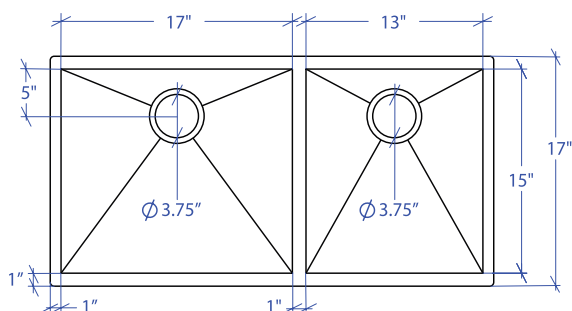

## • FEATURES

- 16-gauge type 304 stainless steel
- 90° zero radius design

## • TECHNICAL INFORMATION

- External dimension: 33" Lx17" Wx10" D
- Basin dimensions:  
Left: 17" Lx15" Wx10" D  
Right: 13" Lx15" Wx10" D

## • FINISHES

- Satin Brushed stainless steel

## • INSTALLATION OPTIONS

- Under-mount

## • MINIMUM CABINET SIZE (I.D.)

- Under-mount 36"

## • DUAL-MOUNT INSTALLATION

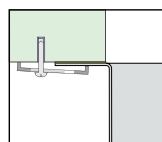

Under-mount

## • ACCESSORY OPTIONS

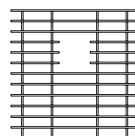

MBG-053SB  
Basin Grid

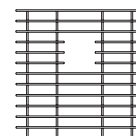

MBG-052SB  
Basin Grid

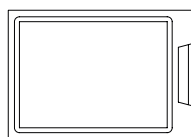

MCB-501BB  
Cutting Board

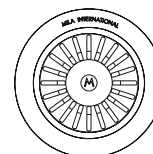

MKD-101SB  
Strainer

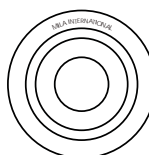

MDC-101SB  
Disposal Collar

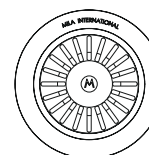

MDC-102SB  
Disposal Collar

PROJECT INFORMATION			
Project			
Date	/ /	QTY	
Specifier			
Contact			
Note			

UNDER-MOUNT