

# FLATIRON MUD-654SB

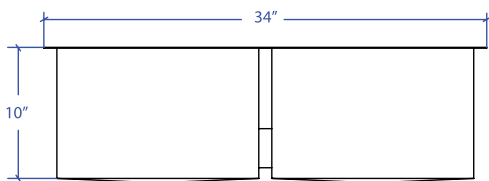

\*Custom ADA compliant versions are available

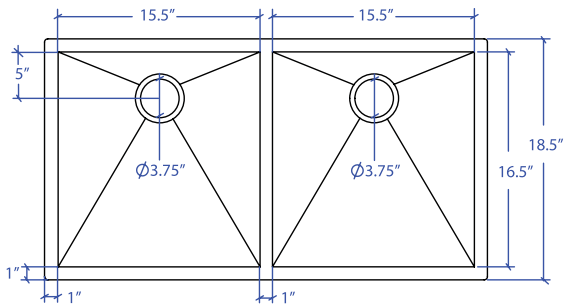

## • FEATURES

- 16-gauge type 304 stainless steel
- 90° zero radius design

## • TECHNICAL INFORMATION

- External dimension: 34"Lx18.5"Wx10"D
- Basin dimensions:
- Left: 15.5"Lx16.5"Wx10"D
- Right: 15.5"Lx16.5"Wx10"D

## • FINISHES

- Satin Brushed stainless steel

## • INSTALLATION OPTIONS

- Under-mount

## • MINIMUM CABINET SIZE (I.D.)

- Under-mount 37" "

## • DUAL-MOUNT INSTALLATION

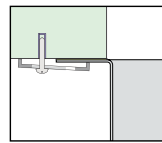

Under-mount

## • ACCESSORY OPTIONS

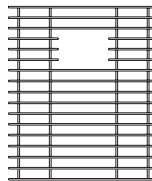

MBG-6503SB  
Basin Grid

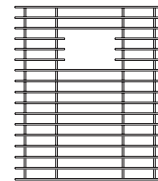

MBG-083SB  
Basin Grid

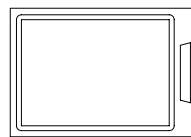

MCB-651BB  
Cutting Board

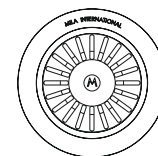

MKD-101SB  
Strainer



MDC-101SB  
Disposal Collar

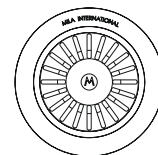

MDC-102SB  
Disposal Collar

PROJECT INFORMATION			
Project			
Date	/ /	QTY	
Specifier			
Contact			
Note			

UNDER-MOUNT