

FLATIRON MPU-651SB

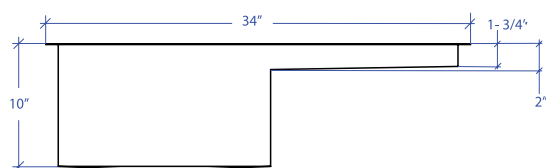

*Custom ADA compliant versions are available

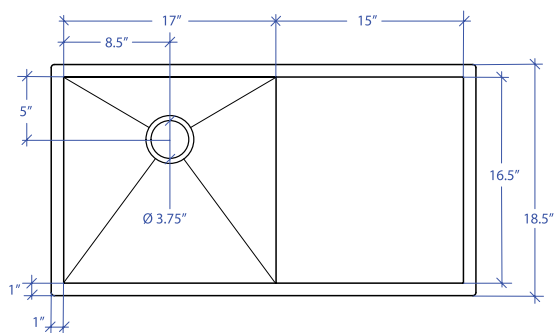

• FEATURES

16-gauge type 304 stainless steel
90° zero radius design

• TECHNICAL INFORMATION

External dimension: 34"Lx18.5"Wx10"D
Basin dimensions: 17"Lx16.5"Wx10"D
Prep o rd 1

• FINISHES

Satin Brushed stainless steel

• INSTALLATION OPTIONS

Under-mount

• MINIMUM CABINET SIZE (I.D.)

Under-mount 36"

• DUAL-MOUNT INSTALLATION

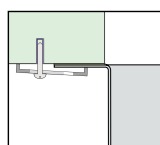

Under-mount

• ACCESSORY OPTIONS

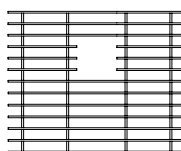

MBG-6505SB
Basin Grid

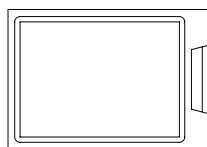

MCB-651BB
Cutting Board

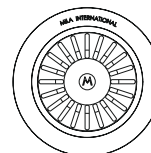

MKD-101SB
Strainer



MDC-101SB
Disposal Collar

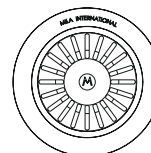

MDC-102SB
Disposal Collar

PROJECT INFORMATION			
Project			
Date	/ /	QTY	
Specifier			
Contact			
Note			

PREPBOARD UNDER-MOUNT