

ARC MARFS-651SB

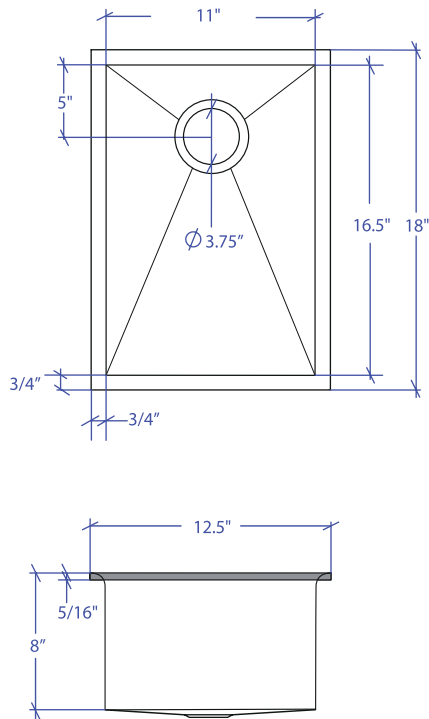

*Flush-Mount Installation Kit is included with each sink
*Custom ADA compliant versions are available



• FEATURES

- 16-gauge type 304 stainless steel
- Solid brass under rim support
- 1/4" round profile basin

• TECHNICAL INFORMATION

- External dimension: 12.5"Lx18"Wx8"D
- Basin dimensions: 11"Lx16.5"Wx8"D
- Frame width: 3/4"
- Frame thickness: 5/16"

• FINISHES

- Satin Brushed stainless steel

• INSTALLATION OPTIONS

- Flush-mount

• MINIMUM CABINET SIZE (I.D.)

- Flush-mount 17.5"

• INDUSTRY'S ONLY STAINLESS STEEL SINK DESIGNED SPECIFICALLY TO BE FLUSH-MOUNTED

• INTERNATIONAL PATENT PENDING

• FLUSH-MOUNT INSTALLATION

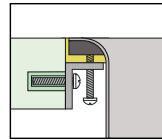

Flush-mount

• ACCESSORIES OPTIONS

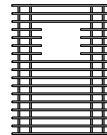

MBG-6515SB
Basin Grid

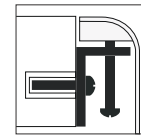

Flush Mount Kit
(Included)
MTK-608AL

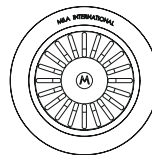

MKD-101SB
Strainer

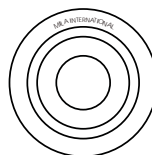

MDC-101SB
Disposal Collar

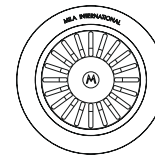

MDC-102SB
Disposal Collar

| PROJECT INFORMATION | | | |
|---------------------|-----|-----|--|
| Project | | | |
| Date | / / | QTY | |
| Specifier | | | |
| Contact | | | |
| Note | | | |