

# ATELIER MTS-655SB

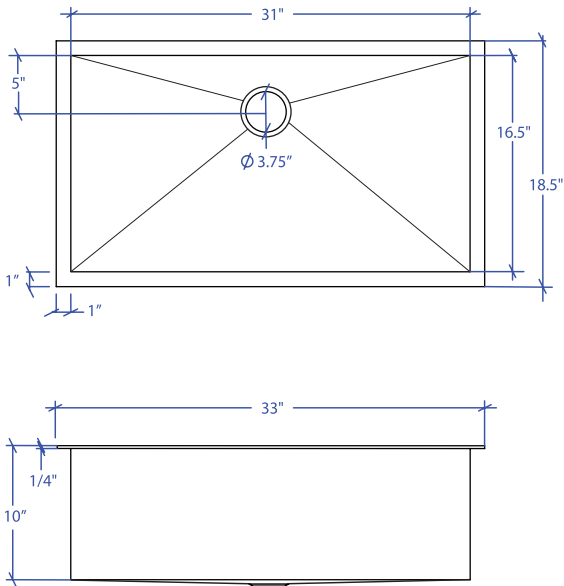

\*Custom ADA compliant sinks are available



## • FEATURES

16-gauge type 304 stainless steel  
TRI-MOUNT™ installation system

## • TECHNICAL INFORMATION

External dimension: 33"Lx18.5"Wx10"D  
Basin dimensions: 31"Lx16.5"Wx10"D  
Rim width: 1"  
Rim thickness: 1/4"

## • FINISHES

Satin brushed stainless steel

## • INSTALLATION OPTIONS

Flush-mount  
Drop-in  
Under-mount

## • MINIMUM CABINET SIZE (I.D.)

Flush-mount 36"  
Drop-in 33"  
Under-mount 37"

## • INDUSTRY'S ONLY STAINLESS STEEL SINK DESIGNED SPECIFICALLY TO BE FLUSH-MOUNTED

## • U.S. PATENT NO. 9,988,799

## • CANADIAN PATENT NO. 2579506

## • TRI-MOUNT INSTALLATION

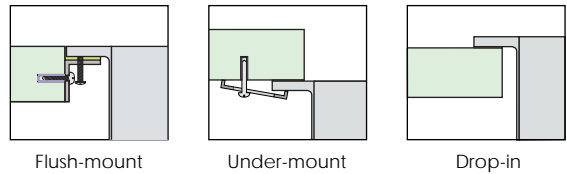

## • ACCESSORIES

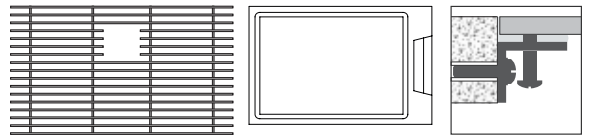

MBG-6514SB  
Basin Grid

MCB-651BB  
Cutting Board

MTK-605AL  
Mounting Kit

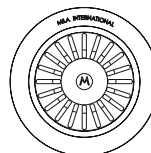

MKD-101SB  
Strainer

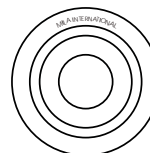

MDC-101SB  
Disposal Collar

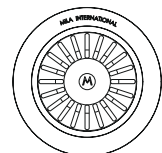

MDC-102SB  
Disposal Collar

PROJECT INFORMATION			
Project			
Date	/ /	QTY	
Specifier			
Contact			
Note			