

ATELIER MTS-800SB

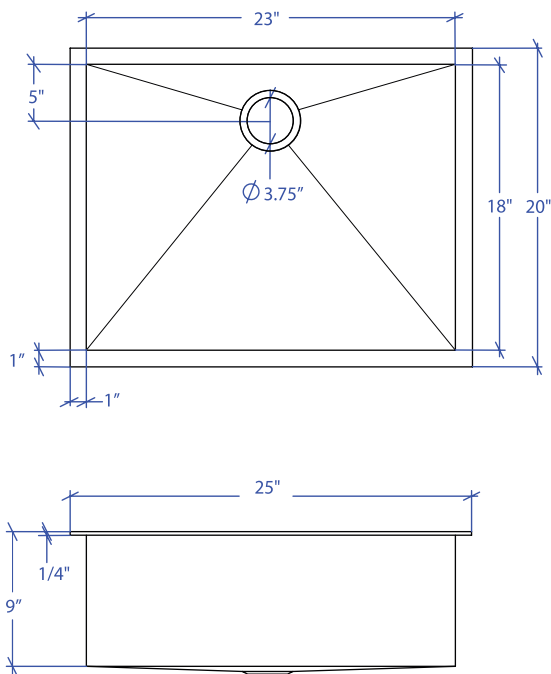

*Custom ADA compliant sinks are available



• FEATURES

16-gauge type 304 stainless steel
TRI-MOUNT™ installation system

• TECHNICAL INFORMATION

External dimension: 25" Lx20" Wx9" D
Basin dimensions: 23" Lx18" Wx9" D
Rim width: 1"
Rim thickness: 1/4"

• FINISHES

Satin brushed stainless steel

• INSTALLATION OPTIONS

Flush-mount
Drop-in
Under-mount

• MINIMUM CABINET SIZE (I.D.)

Flush-mount 28"
Drop-in 25"
Under-mount 29"

• INDUSTRY'S ONLY STAINLESS STEEL SINK DESIGNED SPECIFICALLY TO BE FLUSH-MOUNTED

• U.S. PATENT NO. 9,988,799

• CANADIAN PATENT NO. 2579506

• TRI-MOUNT INSTALLATION

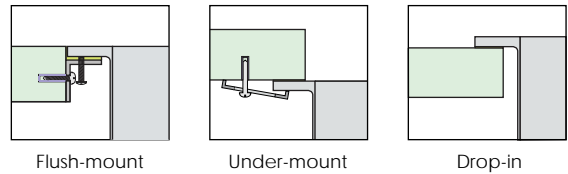

• ACCESSORIES

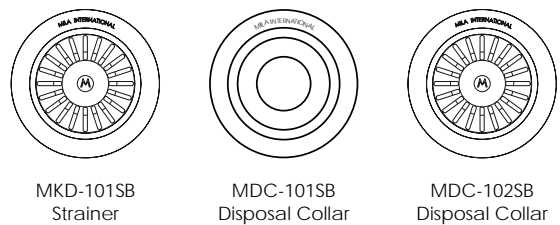
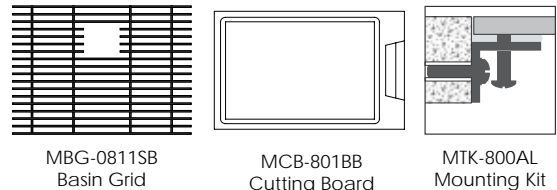

PROJECT INFORMATION			
Project			
Date	/ /	QTY	
Specifier			
Contact			
Note			