

CRESCENT MCFS-651GPSB

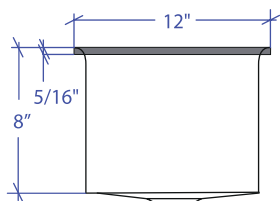

*Flush-Mount Installation Kit is included with each sink
*Custom ADA compliant versions are available

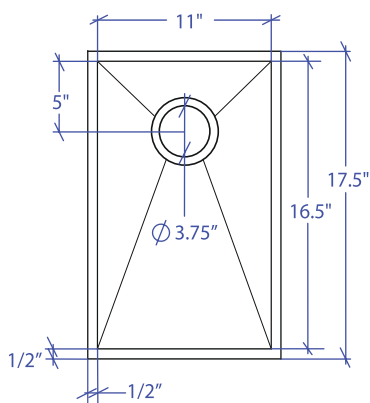

• FEATURES

- 16-gauge type 304 stainless steel
- Solid brass under rim support
- 1/4" round profile basin

• TECHNICAL INFORMATION

- External dimension: 12"Lx17.5"Wx8"D
- Basin dimensions: 11"Lx16.5"Wx8"D
- Frame width: 1/2"
- Frame thickness: 5/16"

• FINISHES

- Graphite PVD Satin Brushed stainless steel

• INSTALLATION OPTIONS

- Flush-mount

• MINIMUM CABINET SIZE (I.D.)

- Flush-mount 15"

• INDUSTRY'S ONLY STAINLESS STEEL SINK DESIGNED SPECIFICALLY TO BE FLUSH-MOUNTED

• INTERNATIONAL PATENT PENDING

• FLUSH-MOUNT INSTALLATION

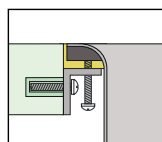

Flush-mount

• ACCESSORIES OPTIONS

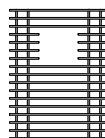

MBG-6515GPSB
Basin Grid

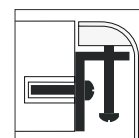

Flush Mount Kit
(Included)
MTK-614AL

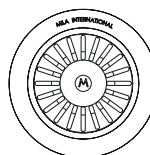

MKD-101GPSB
Strainer

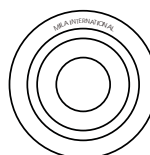

MDC-101GPSB
Disposal Collar

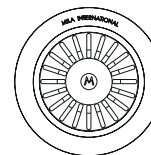

MDC-102GPSB
Disposal Collar

PROJECT INFORMATION			
Project			
Date	/ /	QTY	
Specifier			
Contact			
Note			