

ATELIER MTD-502SB

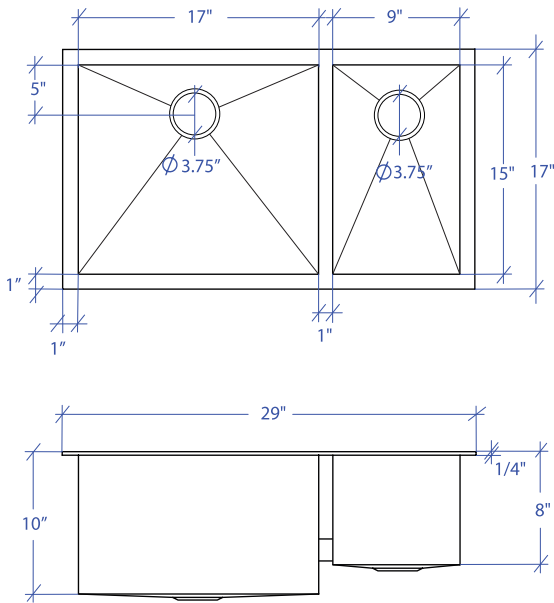

*Custom ADA compliant sinks are available



• FEATURES

16-gauge type 304 stainless steel
TRI-MOUNT™ installation system

• TECHNICAL INFORMATION

External dimension: 29" L x 17" W x 10" D
Basin dimensions:
Left: 17" L x 15" W x 10" D
Right: 9" L x 15" W x 8" D
Frame width: 1"
Frame thickness: 1/4" t

• FINISHES

Satin Brushed stainless steel

• INSTALLATION OPTIONS

Flush-mount
Drop-in
Under-mount

• MINIMUM CABINET SIZE (I.D.)

Flush-mount 32"
Drop-in 29"
Under-mount 33"

• INDUSTRY'S ONLY STAINLESS STEEL SINK DESIGNED SPECIFICALLY TO BE FLUSH-MOUNTED

• U.S. PATENT NO. 9,988,799

• CANADIAN PATENT NO. 2579506

• TRI-MOUNT INSTALLATION

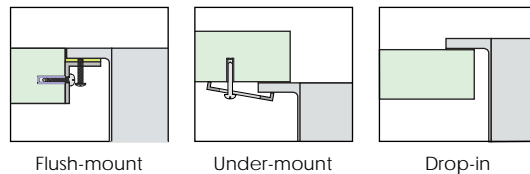

• ACCESSORIES

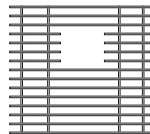

MBG-053SB
Basin Grid

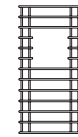

MBG-051SB
Basin Grid



MCB-501BB
Cutting Board

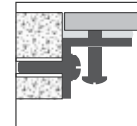

MTK-106AL
Mounting Kit

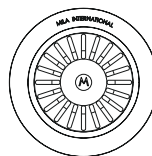

MKD-101SB
Strainer

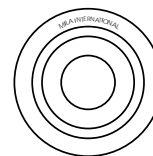

MDC-101SB
Disposal Collar

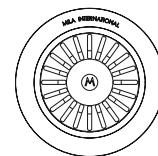

MDC-102SB
Disposal Collar

PROJECT INFORMATION			
Project			
Date	/ /	QTY	
Specifier			
Contact			
Note			