

WORKSTATION MFWS-637GDSB

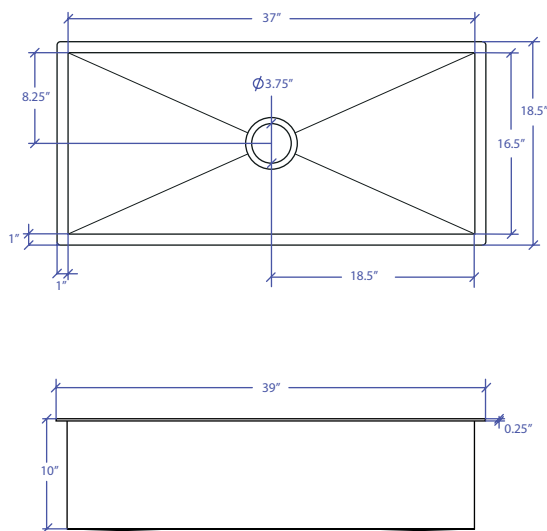

INDUSTRY'S ONLY STAINLESS STEEL SINK DESIGNED SPECIFICALLY TO BE FLUSH-MOUNTED



- **FEATURES**
16-gauge type 304 stainless steel
5-gauge 304 stainless steel rim
- **TECHNICAL INFORMATION**
External dimension: 39"Lx18.5"Wx10"D
Basin dimensions: 37"Lx16.5"Wx10"D
Rim width: 1"
Rim thickness: 1/4"
Rim Corner: 1/4" round
- **FINISHES**
Gold PVD Satin Brushed stainless steel
- **INSTALLATION OPTIONS**
Flush-mount
- **MINIMUM CABINET SIZE (I.D.)**
Flush-mount 41"
- **INSTALLATION TYPE**

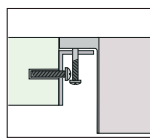

Flush-mount

INCLUDED ACCESSORIES



Flush Mount Kit
MTK-620AL

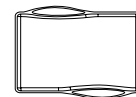

MWCB-651GDSB
Cutting Board

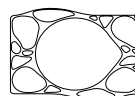

MWSM-651GDSB
Salad Mixer

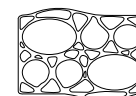

MWBM-651GDSB
Bain Marie

OPTIONAL ACCESSORIES



MBG-6519GDSB
Basin Grid



MWC-651GDSB
Colander



MWSS-651GDSB
Side Sink

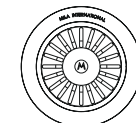

MKD-101GDSB
Strainer



MDC-101GDSB
Disposal Collar

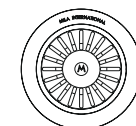

MDC-102GDSB
Disposal Collar

US Patent No. 9,988,799 CA Patent No. 2579506
International Patent Pending

PROJECT INFORMATION			
Project			
Date	/ /	QTY	
Specifier			
Contact			
Note			