

ATELIER MTD-654SB

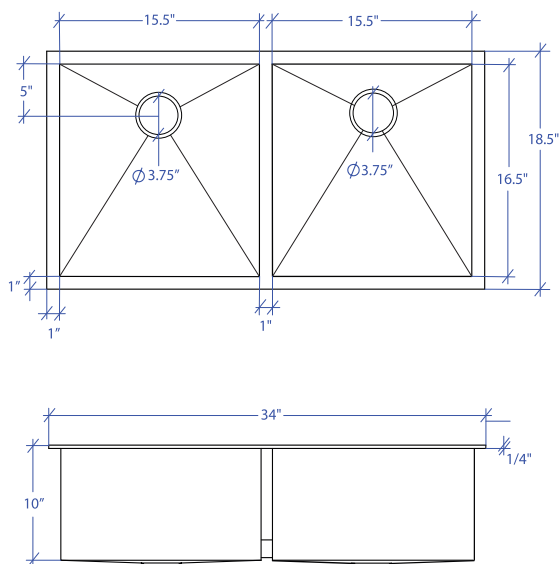

*Custom ADA compliant sinks are available



- FEATURES**
 16-gauge type 304 stainless steel
 TRI-MOUNT™ installation system
- TECHNICAL INFORMATION**
 External dimension: 34" L x 18.5" W x 10" D
 Basin dimensions:
 Left: 15.5" L x 16.5" W x 10" D
 Right: 15.5" L x 16.5" W x 10" D
 Rim width: 1"
 Rim thickness: 1/4"
- FINISHES**
 Satin brushed stainless steel
- INSTALLATION OPTIONS**
 Flush-mount
 Drop-in
 Under-mount
- MINIMUM CABINET SIZE (I.D.)**
 Flush-mount 37"
 Drop-in 34"
 Under-mount 38"

INDUSTRY'S ONLY STAINLESS STEEL SINK DESIGNED SPECIFICALLY TO BE FLUSH-MOUNTED

- U.S. PATENT NO. 9,988,799**
CANADIAN PATENT NO. 2579506
TRI-MOUNT INSTALLATION

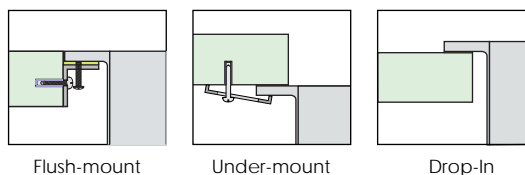

ACCESSORIES

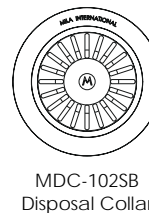
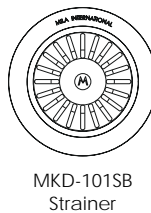
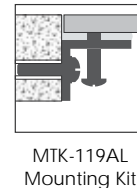
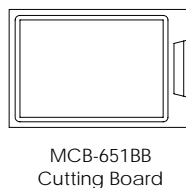
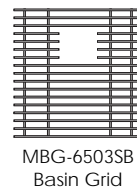
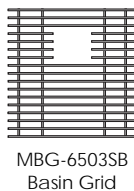

PROJECT INFORMATION			
Project			
Date	/ /	QTY	
Specifier			
Contact			
Note			