

ATELIER MPS-651SB

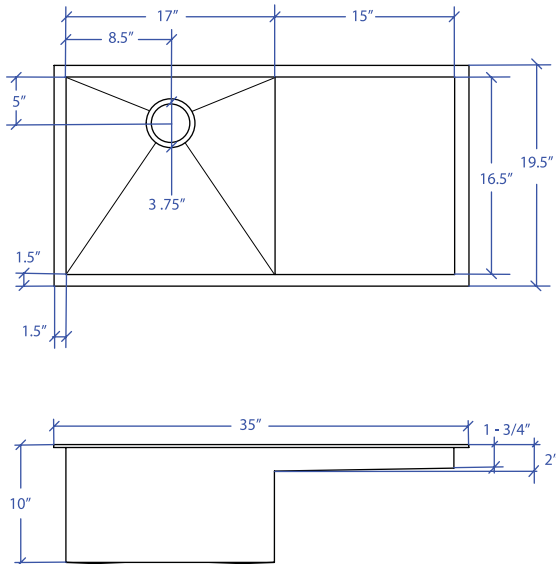

*Custom ADA compliant sinks are available



• FEATURES

16-gauge type 304 stainless steel
TRI-MOUNT™ installation system

• TECHNICAL INFORMATION

External dimension: 35" Lx19.5" Wx10" D
Basin dimensions: 17" Lx16.5" Wx10" D
Prep board: 15"
Frame width: 1-1/2"
Frame thickness: 1/4"

• FINISHES

Satin Brushed stainless steel

• INSTALLATION OPTIONS

Flush-mount
Drop-In
Under-mount

• MINIMUM CABINET SIZE (I.D.)

Flush-mount 37"
Drop-In 34"
Under-mount 38"

• INDUSTRY'S ONLY STAINLESS STEEL SINK DESIGNED SPECIFICALLY TO BE FLUSH-MOUNTED

• U.S. PATENT NO. 9,988,799

• CANADIAN PATENT NO. 2579506

• TRI-MOUNT INSTALLATION

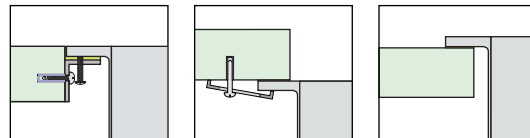

Flush-mount

Under-mount

Drop-In

• ACCESSORIES

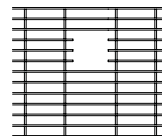

MBG-6505SB
Basin Grid

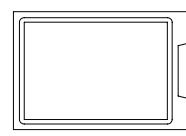

MCB-651BB
Cutting Board

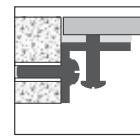

MTK-117AL
Mounting Kit

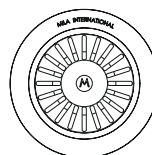

MKD-101SB
Strainer

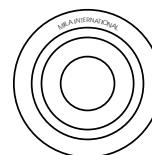

MDC-101SB
Disposal Collar

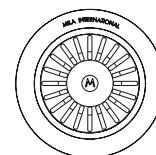

MDC-102SB
Disposal Collar

PROJECT INFORMATION			
Project			
Date	/ /	QTY	
Specifier			
Contact			
Note			

PREP BOARD TRI-MOUNT™