

# FLUSH-MOUNT BRACKET KIT MTK-118AL

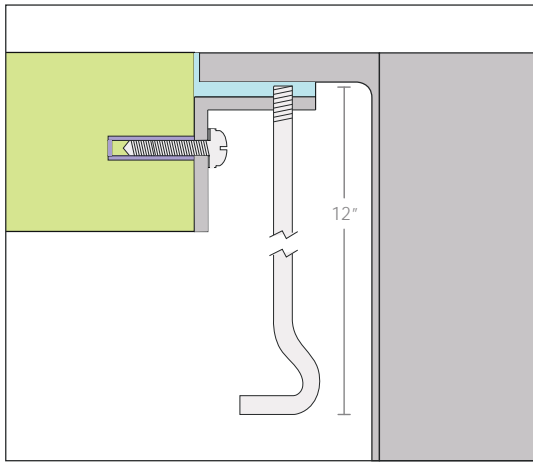

## DESCRIPTION

Flush-mount Installation Kit

## TECHNICAL INFORMATION

- 16 GA. 304 Stainless Steel Angle
- Stainless Steel 12" Height Adjusting Screw
- Stainless Steel Lock Washers
- Aluminum Anchors

## INCLUDED PARTS

- #8-32 Screw
- 12" Height Adjusting Screw
- #8 Lock Washer
- #8-32 Standoff

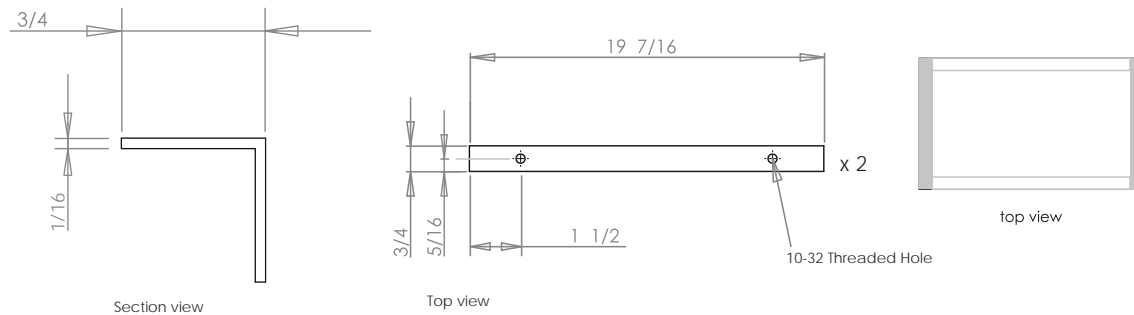
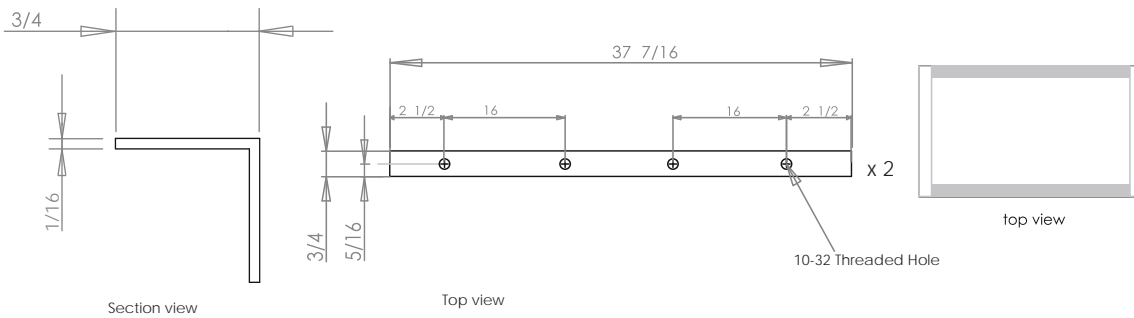
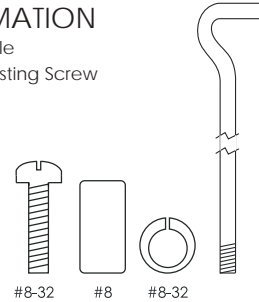

| PROJECT INFORMATION |     |     |  |
|---------------------|-----|-----|--|
| Project             |     |     |  |
| Date                | / / | QTY |  |
| Specifier           |     |     |  |
| Contact             |     |     |  |
| Note                |     |     |  |