

# ORION MOUS-802SB

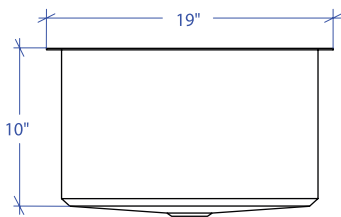

\*Custom ADA compliant sinks are available

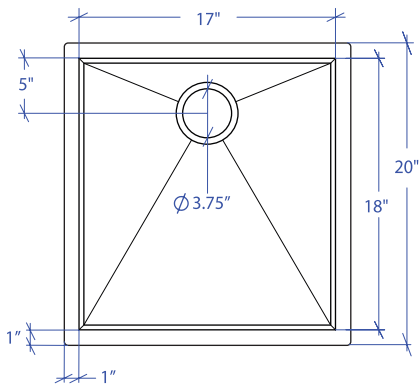

- **FEATURES**  
16-gauge type 304 stainless steel  
Bevel basin design
- **TECHNICAL INFORMATION**  
External dimension: 19" Lx20" Wx10" D  
Basin dimensions: 17" Lx18" Wx10" D
- **FINISHES**  
Satin Brushed stainless steel
- **INSTALLATION OPTIONS**  
Under-mount
- **MINIMUM CABINET SIZE (I.D.)**  
Under-mount 22"

## • US DESIGN PATENT D618,324 S

## • DUAL-MOUNT INSTALLATION

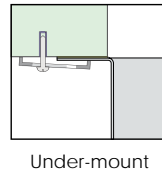

## • ACCESSORY OPTIONS

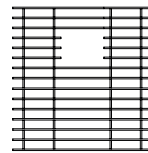

MBG-083SB  
Basin Grid

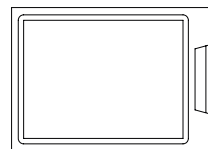

MCB-801BB  
Cutting Board

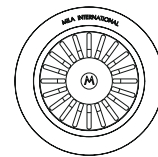

MKD-101SB  
Strainer

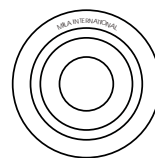

MDC-101SB  
Disposal Collar

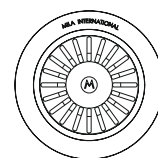

MDC-102SB  
Disposal Collar

PROJECT INFORMATION			
Project			
Date	/ /	QTY	
Specifier			
Contact			
Note			