

ORION MOUD-654SB

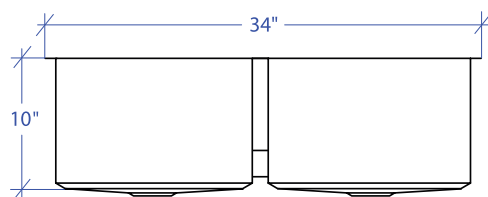

*Custom ADA compliant sinks are available

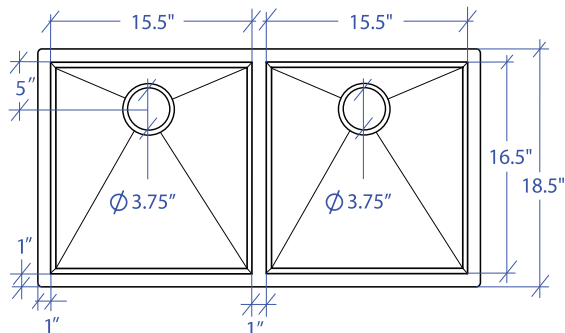

- FEATURES**
 16-gauge type 304 stainless steel
 Bevel basin design
- TECHNICAL INFORMATION**
 External dimension: 34"Lx18.5"Wx10"D
 Basin dimensions:
 Left: 15.5"Lx16.5"Wx10"D
 Right: 15.5"Lx16.5"Wx10"D
- FINISHES**
 Satin Brushed stainless steel
- INSTALLATION OPTIONS**
 Under-mount
- MINIMUM CABINET SIZE (I.D.)**
 Under-mount 37"
- US DESIGN PATENT D618,324 S**

DUAL-MOUNT INSTALLATION

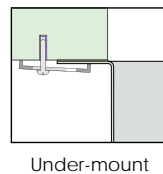

ACCESSORY OPTIONS

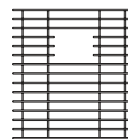

MBG-6503SB
Basin Grid

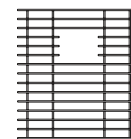

MBG-6503SB
Basin Grid

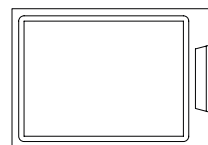

MCB-651BB
Cutting Board

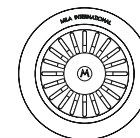

MKD-101SB
Strainer



MDC-101SB
Disposal Collar

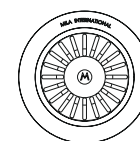

MDC-102SB
Disposal Collar

| PROJECT INFORMATION | | | |
|---------------------|-----|-----|--|
| Project | | | |
| Date | / / | QTY | |
| Specifier | | | |
| Contact | | | |
| Note | | | |