

FLATIRON MUS-502GDSB

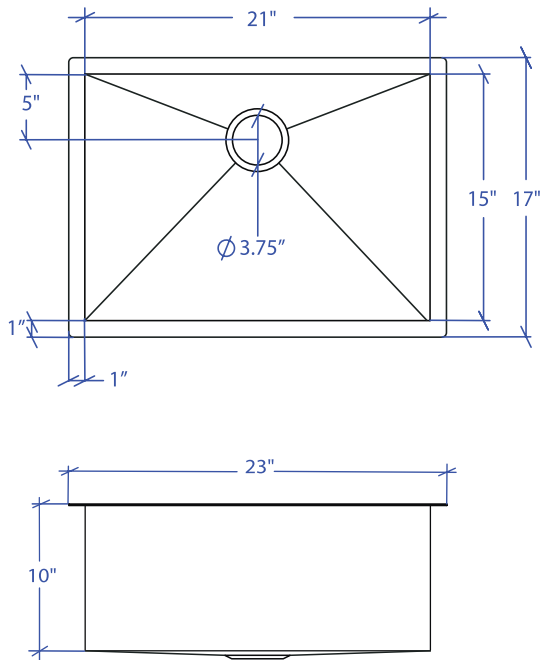

*Custom ADA compliant versions are available



| PROJECT INFORMATION | | | |
|---------------------|-----|-----|--|
| Project | | | |
| Date | / / | QTY | |
| Specifier | | | |
| Contact | | | |
| Note | | | |

- **FEATURES**
16-gauge type 304 stainless steel
90° zero radius design
- **TECHNICAL INFORMATION**
External dimension: 23"Lx17"Wx10"D
Basin dimensions: 21"Lx15"Wx10"D
- **FINISHES**
Gold PVD Satin Brushed stainless steel
- **INSTALLATION OPTIONS**
Under-mount
- **MINIMUM CABINET SIZE (I.D.)**
Under-mount 26"

• DUAL-MOUNT INSTALLATION

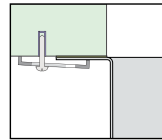

Under-mount

• ACCESSORY OPTIONS

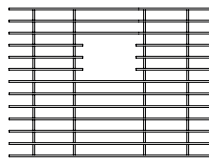

MBG-054GDSB
Basin Grid

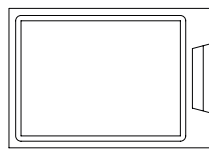

MCB-501BB
Cutting Board

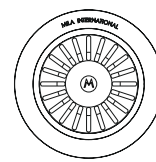

MKD-101GDSB
Strainer

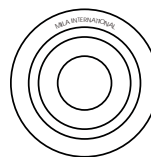

MDC-101GDSB
Disposal Collar

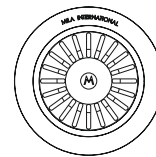

MDC-102GDSB
Disposal Collar

UNDER-MOUNT