

FLATIRON MUD-803SB

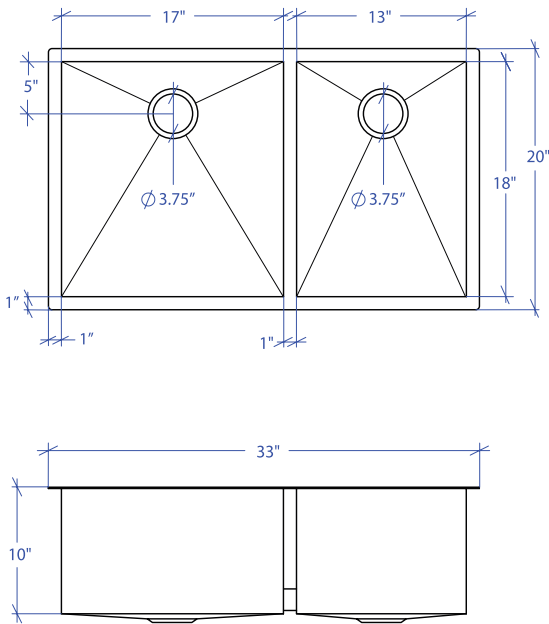

*Custom ADA compliant versions are available



- **FEATURES**
16-gauge type 304 stainless steel
90° zero radius design

- **TECHNICAL INFORMATION**
External dimension: 33"Lx20"Wx10"D
Basin dimensions:
Left: 17"Lx18"Wx10"D
Right: 13"Lx18"Wx10"D
Rim width: 1"
Rim thickness: 1/16"

- **FINISHES**
Satin brushed stainless steel

- **INSTALLATION OPTIONS**
Under-mount

- **MINIMUM CABINET SIZE (I.D.)**
Under-mount 36"

- **DUAL-MOUNT INSTALLATION**

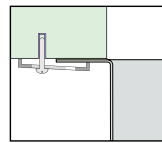

Under-mount

- **ACCESSORY OPTIONS**

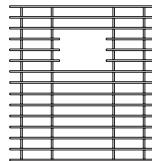

MBG-083SB
Basin Grid

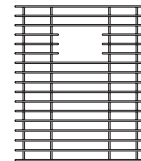

MBG-082SB
Basin Grid

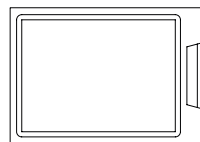

MCB-801BB
Cutting Board

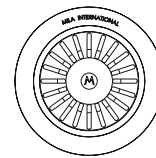

MKD-101SB
Strainer

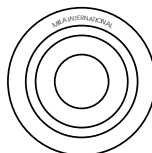

MDC-101SB
Disposal Collar

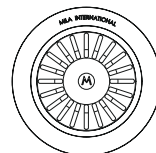

MDC-102SB
Disposal Collar

PROJECT INFORMATION			
Project			
Date	/ /	QTY	
Specifier			
Contact			
Note			

UNDER-MOUNT