

# CRESCENT MCFS-652SB

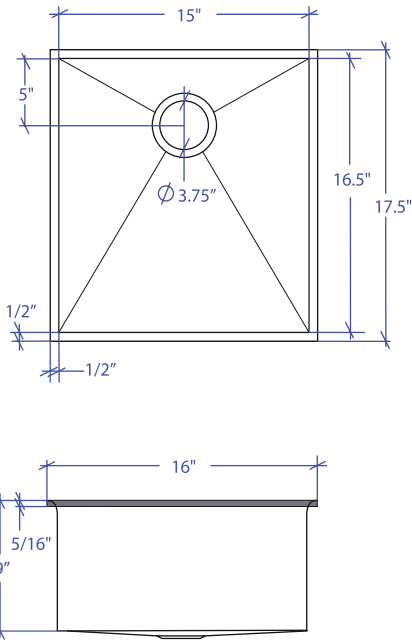

\*Flush-Mount Installation Kit is included with each sink  
\*Custom ADA compliant versions are available



## • FEATURES

16-gauge type 304 stainless steel  
Stainless steel rim support tubing  
1/4" round rim and basin design

## • TECHNICAL INFORMATION

External dimension: 16"Lx17.5"Wx9"D  
Basin dimensions: 15"Lx16.5"Wx9"D  
Rim width: 1/2"  
Rim thickness: 5/16"

## • FINISHES

Satin brushed stainless steel

## • INSTALLATION OPTIONS

Flush-mount

## • MINIMUM CABINET SIZE (I.D.)

Flush-mount 19"

## • INDUSTRY'S ONLY STAINLESS STEEL SINK DESIGNED SPECIFICALLY TO BE FLUSH-MOUNTED

## • INTERNATIONAL PATENT PENDING

## • FLUSH-MOUNT INSTALLATION

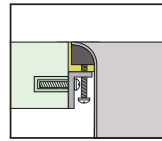

Flush-mount

## • ACCESSORIES OPTIONS

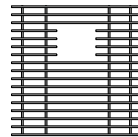

MBG-6502SB  
Basin Grid

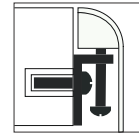

Flush Mount Kit  
(Included)  
MTK-615AL

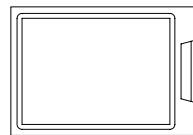

MCB-651BB  
Cutting Board

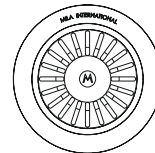

MKD-101B  
Strainer

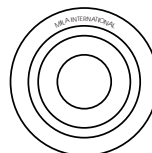

MDC-101SB  
Disposal Collar

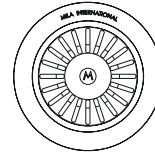

MDC-102SB  
Disposal Collar

## PROJECT INFORMATION

Project			
Date	/ /	QTY	
Specifier			
Contact			
Note			

FLUSH-MOUNT