

WORKSTATION MUWS-637GPSB

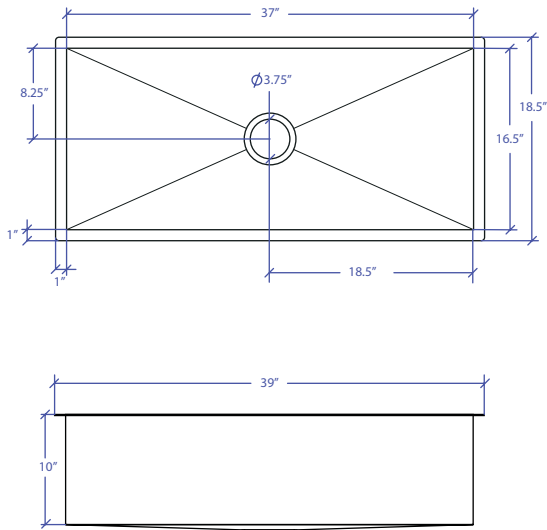

INDUSTRY'S ONLY STAINLESS STEEL SINK DESIGNED SPECIFICALLY TO BE FLUSH-MOUNTED



- FEATURES**
 16-gauge type 304 stainless steel
 EZ clean bevel basin design
 Space saving/ dual slide rail design
- TECHNICAL INFORMATION**
 External dimension: 39" Lx18.5" Wx10" D
 Basin dimensions: 37" Lx16.5" Wx10" D
 Rim width: 1"
 Rim thickness: 1/16"
- FINISHES**
 Graphite PVD Satin Brushed stainless steel
- INSTALLATION OPTIONS**
 Under-mount
- MINIMUM CABINET SIZE (I.D.)**
 Under-mount 41"
- INSTALLATION TYPE**

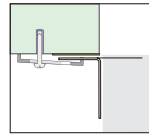

Under-mount

INCLUDED ACCESSORIES

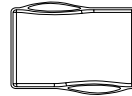

MWCB-651GPBB
Cutting Board

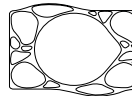

MWSM-651GPSB
Salad Mixer

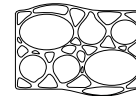

MWBM-651GPSB
Bain Marie

OPTIONAL ACCESSORIES



MBG-6519GPSB
Basin Grid



MWC-651GPSB
Colander

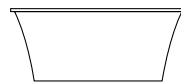

MWSS-651GPSB
Side Sink

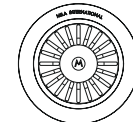

MKD-101GPSB
Strainer



MDC-101GPSB
Disposal Collar

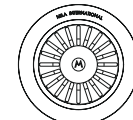

MDC-102GPSB
Disposal Collar

US Patent No. 9,988,799 CA Patent No. 2579506
International Patent Pending

PROJECT INFORMATION			
Project			
Date	/ /	QTY	
Specifier			
Contact			
Note			