

APRON FRONT MAS-805SB

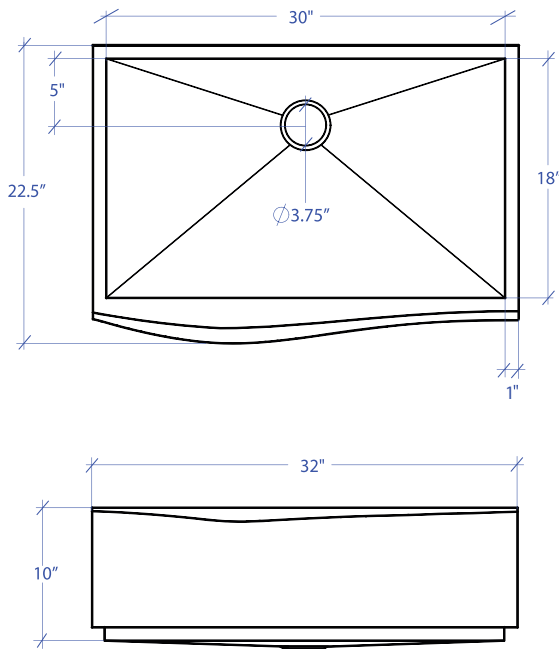

*Custom ADA compliant sinks are available



- **FEATURES**
16-gauge type 304 stainless steel

- **TECHNICAL INFORMATION**
External dimension: 32" Lx22.5" Wx10" D
Basin dimensions: 30" Lx18" Wx10" D

- **FINISHES**
Satin Brushed stainless steel

- **INSTALLATION OPTIONS**
Flush-mount
Under-mount

- **MINIMUM CABINET SIZE (I.D.)**
Flush-mount 35"
Under-mount 35"

- **DUAL-MOUNT INSTALLATION**

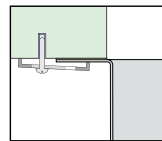

Under-mount

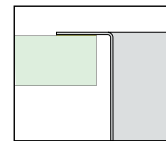

Top-mount

- **ACCESSORY OPTIONS**

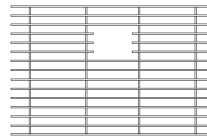

MBG-086SB
Basin Grid

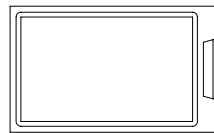

MCB-801BB
Cutting Board

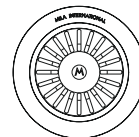

MKD-101SB
Strainer

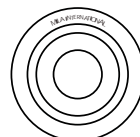

MDC-101SB
Disposal Collar

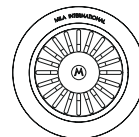

MDC-102SB
Disposal Collar

PROJECT INFORMATION			
Project			
Date	/ /	QTY	
Specifier			
Contact			
Note			

DUAL-MOUNT