

FLUSH-MOUNT BRACKET KIT MTK-606AL

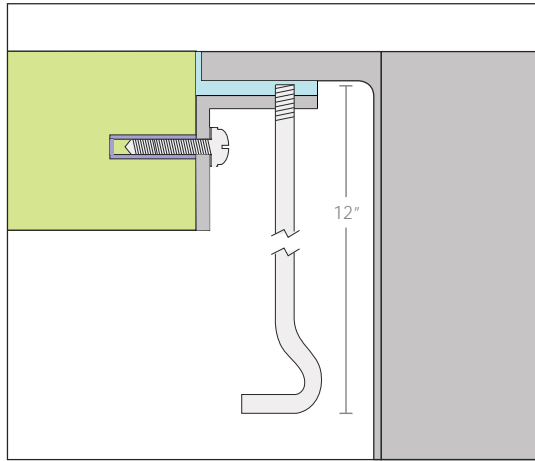

DESCRIPTION

Flush-mount Installation Kit

TECHNICAL INFORMATION

16 GA. 304 Stainless Steel Angle
Stainless Steel 12" Height Adjusting Screw
Stainless Steel Lock Washers
Aluminum Anchors

INCLUDED PARTS

#8-32 Screw
12" Height Adjusting Screw
#8 Lock Washer
#8-32 Standoff

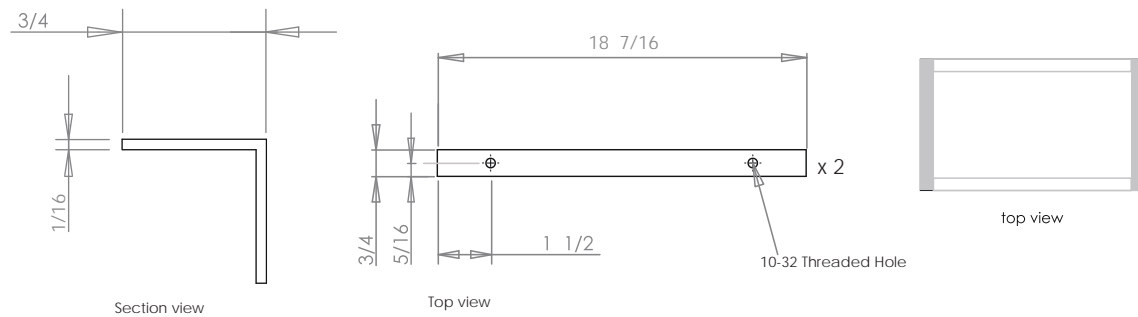
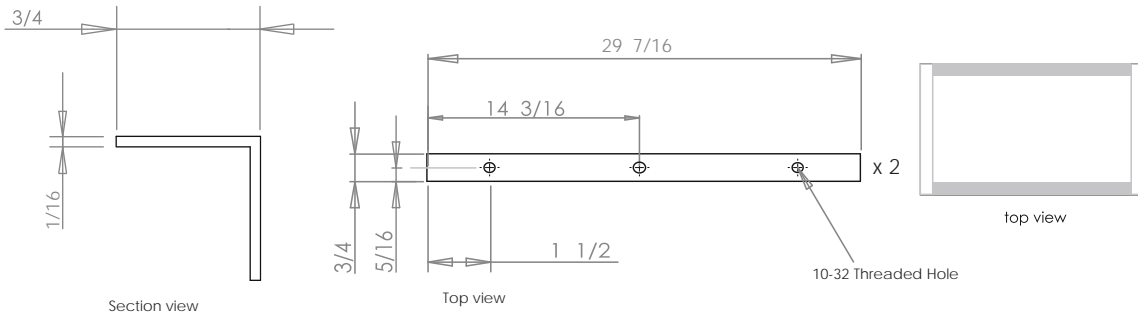
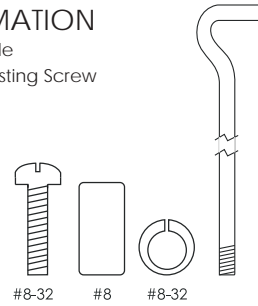

PROJECT INFORMATION			
Project			
Date	/ /	QTY	
Specifier			
Contact			
Note			