

FLUSH-MOUNT BRACKET KIT MTK-801AL

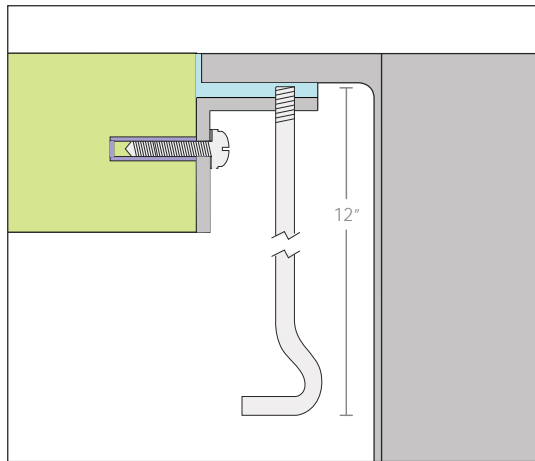

DESCRIPTION

Flush-mount Installation Kit

TECHNICAL INFORMATION

16 GA. 304 Stainless Steel Angle
 Stainless Steel 12" Height Adjusting Screw
 Stainless Steel Lock Washers
 Aluminum Anchors

INCLUDED PARTS

#8-32 Screw
 12" Height Adjusting Screw
 #8 Lock Washer
 #8-32 Standoff

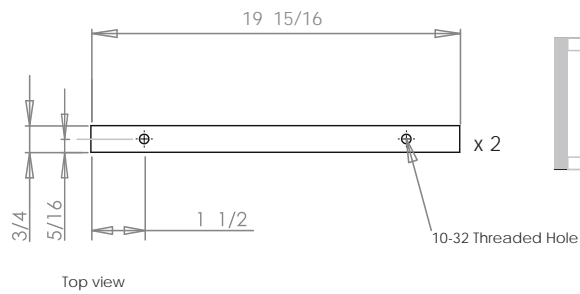
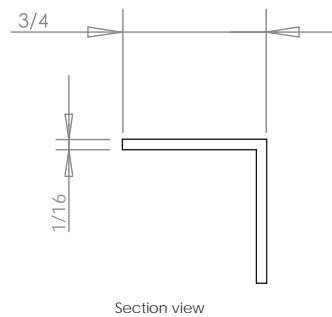
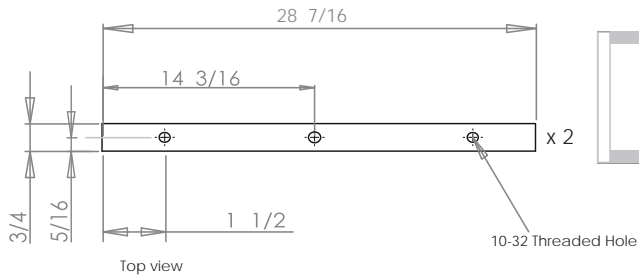
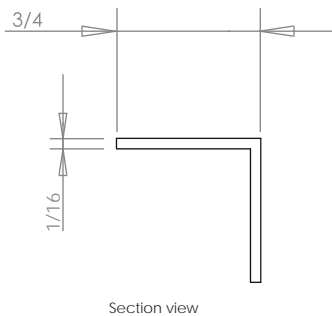
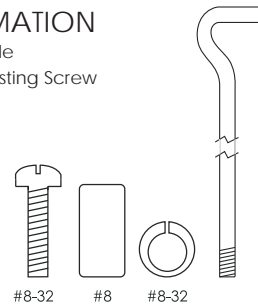

PROJECT INFORMATION			
Project			
Date	/	/	QTY
Specifier			
Contact			
Note			