

ORION MOUD-802SB

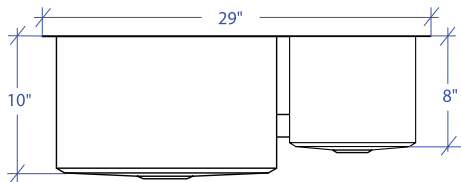

*Custom ADA compliant sinks are available

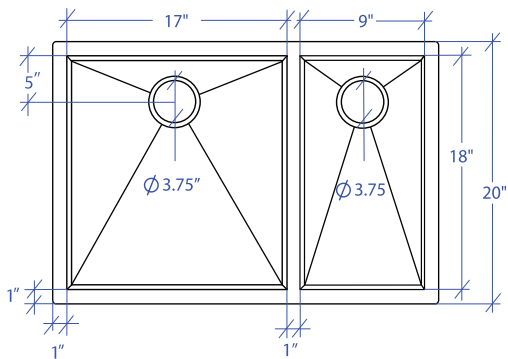

- FEATURES**
 16-gauge type 304 stainless steel
 Bevel basin design
- TECHNICAL INFORMATION**
 External dimension: 29" Lx20" Wx10" D
 Basin dimensions:
 Left: 17" Lx18" Wx10" D
 Right: 9" Lx18" Wx8" D
 Rim width: 1"
 Rim thickness: 1/16"
- FINISHES**
 Satin Brushed stainless steel
- INSTALLATION OPTIONS**
 Under-mount
- MINIMUM CABINET SIZE (I.D.)**
 Under-mount 32"
- US DESIGN PATENT D618,324 S**

- DUAL-MOUNT INSTALLATION**

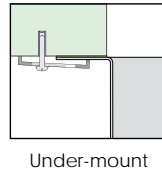

- ACCESSORY OPTIONS**

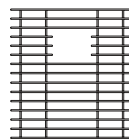

MBG-083SB
Basin Grid

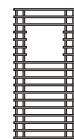

MBG-081SB
Basin Grid

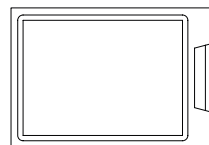

MCB-801BB
Cutting Board

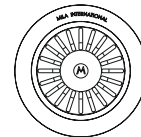

MKD-101SB
Strainer



MDC-101SB
Disposal Collar

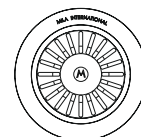

MDC-102SB
Disposal Collar

PROJECT INFORMATION			
Project			
Date	/ /	QTY	
Specifier			
Contact			
Note			

UNDER-MOUNT