

# FLATIRON MUS-502SB

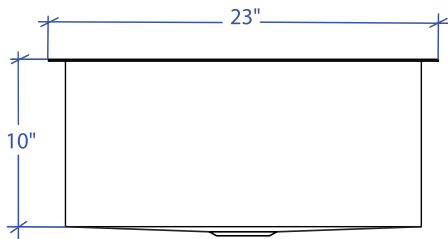

\*Custom ADA compliant versions are available

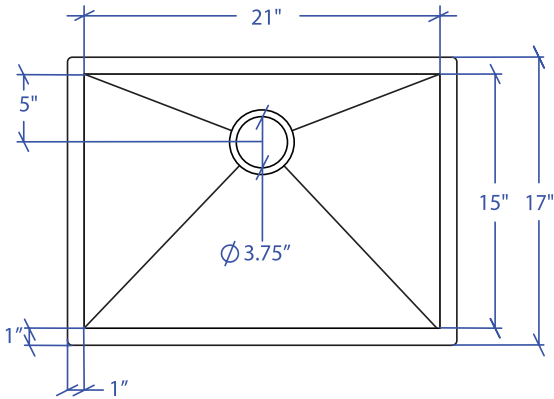

## • FEATURES

- 16-gauge type 304 stainless steel
- 90° zero radius design

## • TECHNICAL INFORMATION

- External dimension: 23"Lx17"Wx10"D
- Basin dimensions: 21"Lx15"Wx10"D
- Rim width: 1"
- Rim thickness: 1/16"

## • FINISHES

- Satin brushed stainless steel

## • INSTALLATION OPTIONS

- Under-mount

## • MINIMUM CABINET SIZE (I.D.)

- Under-mount 26"

## • DUAL-MOUNT INSTALLATION

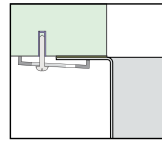

Under-mount

## • ACCESSORY OPTIONS

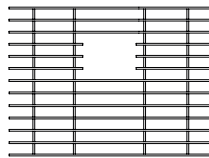

MBG-054SB  
Basin Grid

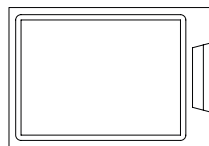

MCB-501BB  
Cutting Board

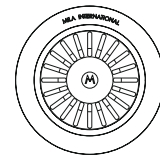

MKD-101SB  
Strainer



MDC-101SB  
Disposal Collar

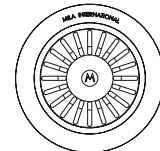

MDC-102SB  
Disposal Collar

PROJECT INFORMATION			
Project			
Date	/ /	QTY	
Specifier			
Contact			
Note			

UNDER-MOUNT