

# FLATIRON MUS-504SB

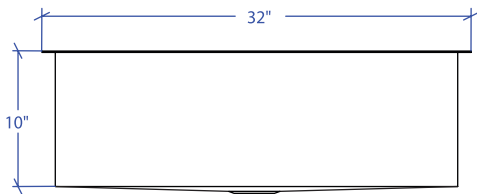

\*Custom ADA compliant versions are available

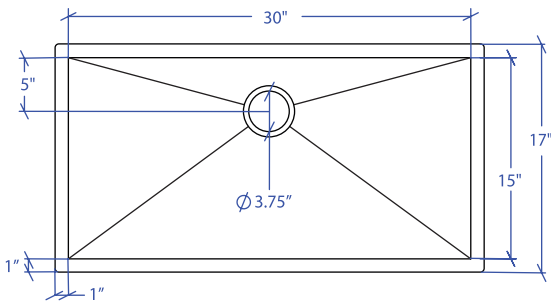

## • FEATURES

- 16-gauge type 304 stainless steel
- 90° zero radius design

## • TECHNICAL INFORMATION

- External dimension: 32"Lx17"Wx10"D
- Basin dimensions: 30"Lx15"Wx10"D
- Rim width: 1"
- Rim thickness: 1/16"

## • FINISHES

- Satin Brushed stainless steel

## • INSTALLATION OPTIONS

- Under-mount

## • MINIMUM CABINET SIZE (I.D.)

- Under-mount 35"

## • DUAL-MOUNT INSTALLATION

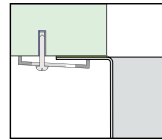

Under-mount

## • ACCESSORY OPTIONS

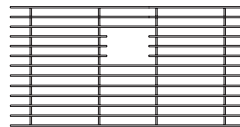

MBG-056SB  
Basin Grid

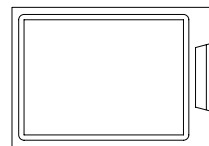

MCB-501BB  
Cutting Board

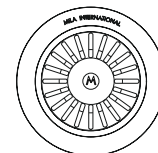

MKD-101SB  
Strainer

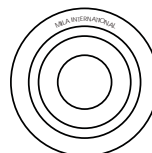

MDC-101SB  
Disposal Collar

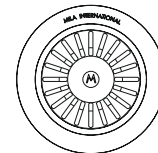

MDC-102SB  
Disposal Collar

## PROJECT INFORMATION

Project			
Date	/ /	QTY	
Specifier			
Contact			
Note			

UNDER-MOUNT