

FLATIRON MUS-654GDSB

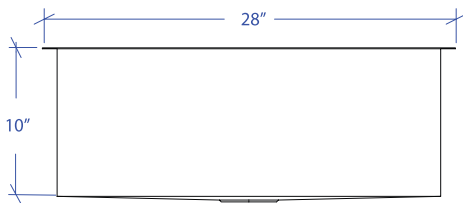

*Custom ADA compliant versions are available

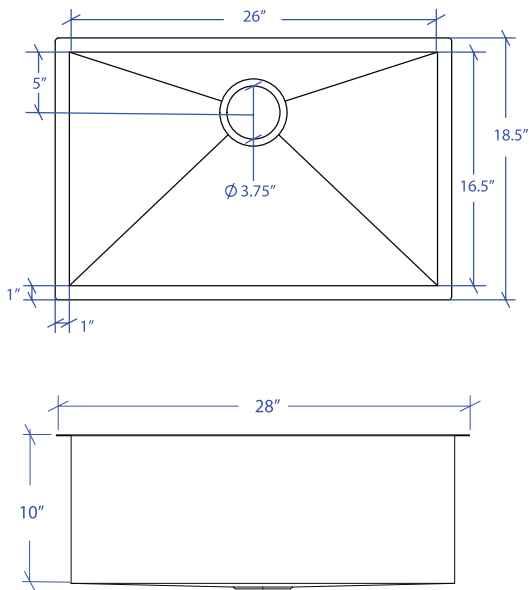

- **FEATURES**
16-gauge type 304 stainless steel
90° zero radius design

- **TECHNICAL INFORMATION**
External dimension: 28" Lx18.5" Wx10" D
Basin dimensions: 26" Lx16.5" Wx10" D
Rim width: 1"
Rim thickness: 1/16"

- **FINISHES**
Gold PVD Satin Brushed stainless steel

- **INSTALLATION OPTIONS**
Under-mount

- **MINIMUM CABINET SIZE (I.D.)**
Under-mount 31"

- **DUAL-MOUNT INSTALLATION**

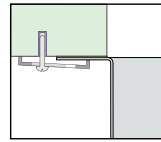

Under-mount

- **ACCESSORY OPTIONS**

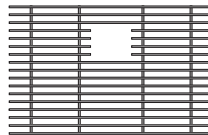

MBG-6510GDSB
Basin Grid

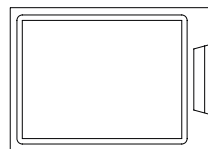

MCB-651BB
Cutting Board

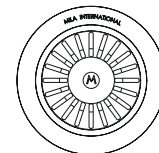

MKD-101GDSB
Strainer



MDC-101GDSB
Disposal Collar

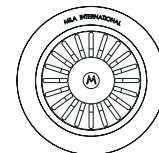

MDC-102GDSB
Disposal Collar

PROJECT INFORMATION			
Project			
Date	/ /	QTY	
Specifier			
Contact			
Note			

UNDER-MOUNT