

FLATIRON MUS-656GPSB

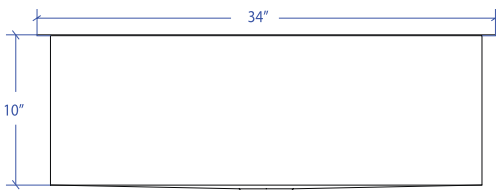

*Custom ADA compliant versions are available

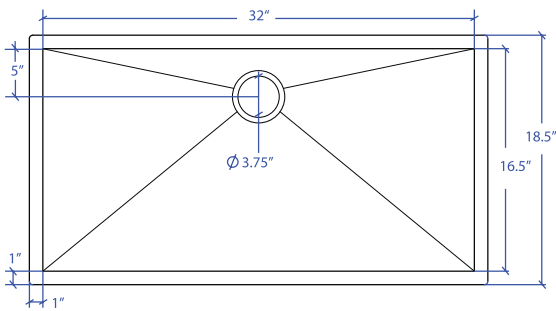

• FEATURES

- 16-gauge type 304 stainless steel
- 90° zero radius design

• TECHNICAL INFORMATION

- External dimension: 34" L x 18.5" W x 10" D
- Basin dimensions: 32" L x 16.5" W x 10" D
- Rim width: 1"
- Rim thickness: 1/16"

• FINISHES

- Graphite PVD satin brushed stainless steel

• INSTALLATION OPTIONS

- Under-mount

• MINIMUM CABINET SIZE (I.D.)

- Under-mount 37"

• DUAL-MOUNT INSTALLATION

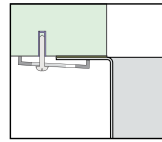

Under-mount

• ACCESSORY OPTIONS

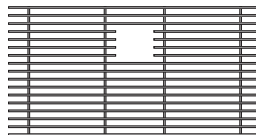

MBG-6513GPSB
Basin Grid

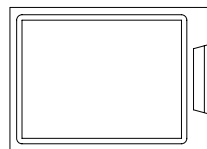

MCB-651BB
Cutting Board

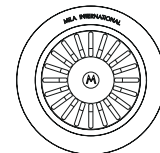

MKD-101GPSB
Strainer

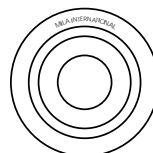

MDC-101GPSB
Disposal Collar

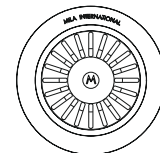

MDC-102GPSB
Disposal Collar

PROJECT INFORMATION

Project			
Date	/ /	QTY	
Specifier			
Contact			
Note			