

FLATIRON MUS-657SB

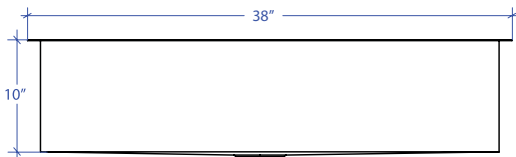

*Custom ADA compliant versions are available

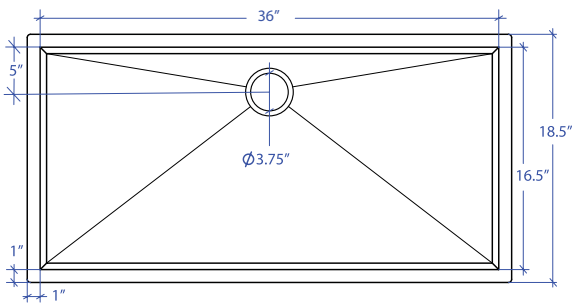

• FEATURES

- 16-gauge type 304 stainless steel
- 90° zero radius design

• TECHNICAL INFORMATION

- External dimension: 38" Lx18.5" Wx10" D
- Basin dimensions: 36" Lx16.5" Wx10" D
- Rim width: 1"
- Rim thickness: 1/16"

• FINISHES

- Satin brushed stainless steel

• INSTALLATION OPTIONS

- Under-mount

• MINIMUM CABINET SIZE (I.D.)

- Under-mount 42"

• DUAL-MOUNT INSTALLATION

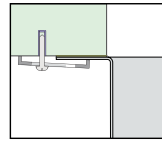

Under-mount

• ACCESSORY OPTIONS

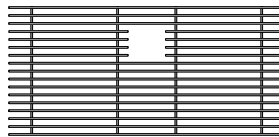

MBG-6518SB
Basin Grid

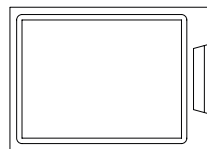

MCB-651BB
Cutting Board

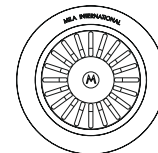

MKD-101SB
Strainer

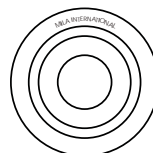

MDC-101SB
Disposal Collar

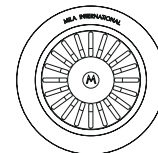

MDC-102SB
Disposal Collar

PROJECT INFORMATION			
Project			
Date	/ /	QTY	
Specifier			
Contact			
Note			

UNDER-MOUNT